

4-CHANNEL LOW CAPACITANCE ESD PROTECTION DIODES ARRAY

DESCRIPTIONS

The LRC099-04BT1G is a 4-channel ultra low capacitance rail clamp ESD protection diodes array. Each channel consists of a pair of ESD diodes that steer positive or negative ESD current to either the positive or negative rail. A zener diode is integrated in to the array between the positive and negative supply rails. In the typical applications, the negative rail pin (assigned as GND) is connected with system ground. The Positive ESD current is steered to the ground through an ESD diode and Zener diode and the positive ESD voltage is clamped to the zener voltage. The LRC099-04BT1G is idea to protect high speed data lines. Three package type is provided for easy PCB layout.

LRC099-04BT1G

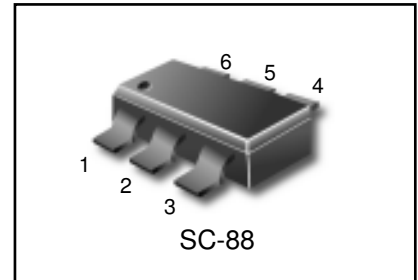

FEATURES

- * 4 channels of ESD protection;
- * Provides ESD protection to IEC61000-4-2 level 4
 - $\pm 15\text{kV}$ air discharge
 - $\pm 8\text{kV}$ contact discharge;
- * Channel I/O to GND capacitance: 0.9pF(Max)
- * Channel I/O to I/O capacitance: 0.45pF(Max)
- * Low clamping voltage;
- * Low operating voltage;
- * Improved zener structure;
- * Optimized package for easy high speed data lines PCB layout;
- * RoHS compliant.

APPLICATIONS

- * HDMI / DVI ports;
- * Display Port interface;
- * 10M / 100M / 1G Ethernet;
- * USB 2.0 interface;
- * VGA interface
- * Set-top box;
- * Flat panel Monitors / TVs;
- * PC / Note book

ORDERING INFORMATION

Part No.	Package	Marking	Material	Shipping
LRC099-04BT1G	SC-88	C96	Halogen Free	3000Tape&Reel

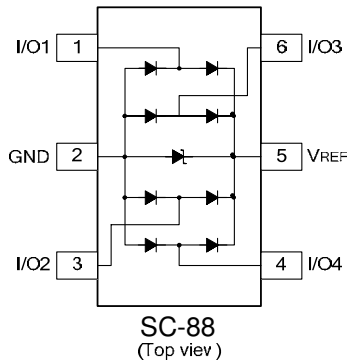
PIN CONFIGURATION

ABSOLUTE MAXIMUM RATINGS

Characteristics	Symbol	Ratings	Unit
Peak Pulse Power(8/20 μ s)	P _{PP}	150	W
Peak Pulse Current(8/20 μ s)	I _{PP}	5	A
ESD per IEC 61000-4-2(Air)	V _{ESD1}	\pm 15kV	kV
ESD per IEC 61000-4-2(Contact)	V _{ESD2}	\pm 8kV	kV
Operating Temperature Range	T _{opr}	-55 ~ +125	$^{\circ}$ C
Storage Temperature Range	T _{stg}	-55 ~ +150	$^{\circ}$ C

ELECTRICAL CHARACTERISTICS(T_{amb}=25 $^{\circ}$ C)

Characteristics	Symbol	Test Conditions	Min.	Typ.	Max.	Unit
Reverse Working Voltage	V _{RWM}	Any I/O pin to GND			5	V
Reverse Breakdown Voltage	V _{BR}	I _T =1mA; Any I/O pin to GND	6			V
Reverse Leakage Current	I _R	V _{RWM} =5V, T=25 $^{\circ}$ C; Any I/O pin to GND			1	μ A
Positive Clamping Voltage	V _{C1}	I _{PP} =1A, t _P =8/20 μ s; Positive pulse; Any I/O pin to GND		8.5	12.0	V
Negative Clamping Voltage	V _{C2}	I _{PP} =1A, t _P =8/20 μ s; Negative pulse; Any I/O pin to GND		1.8		V
Junction Capacitance Between Channel	C _{J1}	V _R =0V, f=1MHz; Between I/O pins		0.35	0.45	pF
Junction Capacitance Between I/O And GND	C _{J2}	V _R =0V, f=1MHz; Any I/O pin to GND			0.9	pF

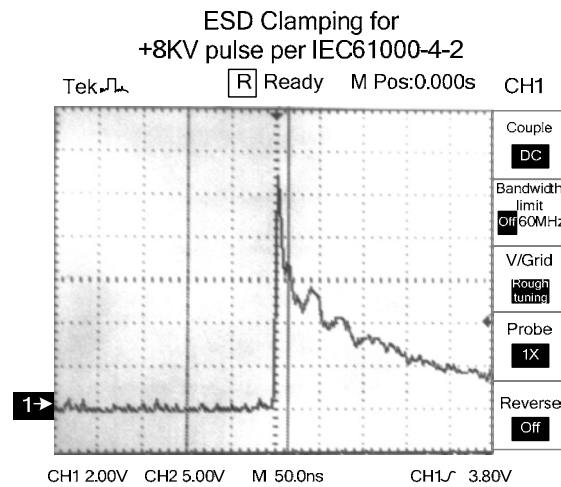
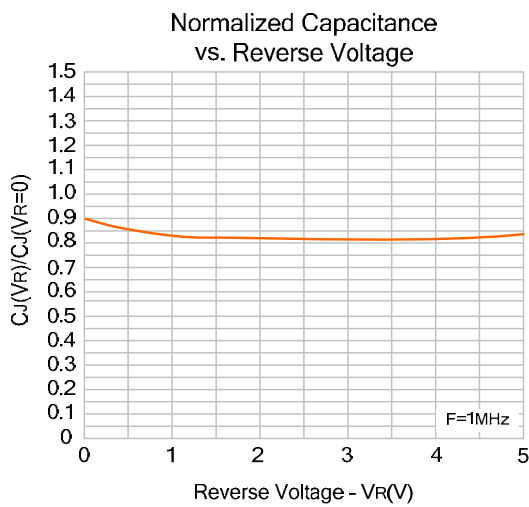
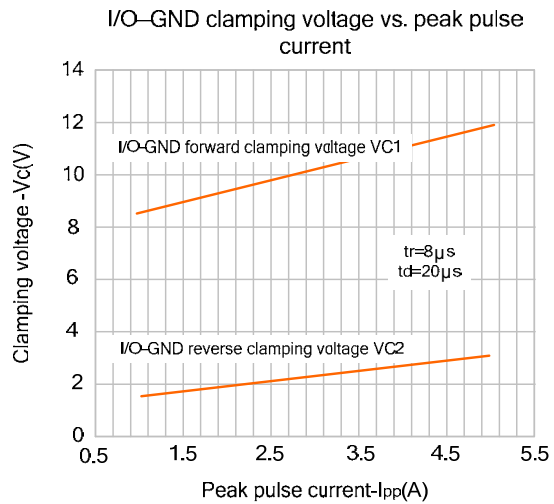
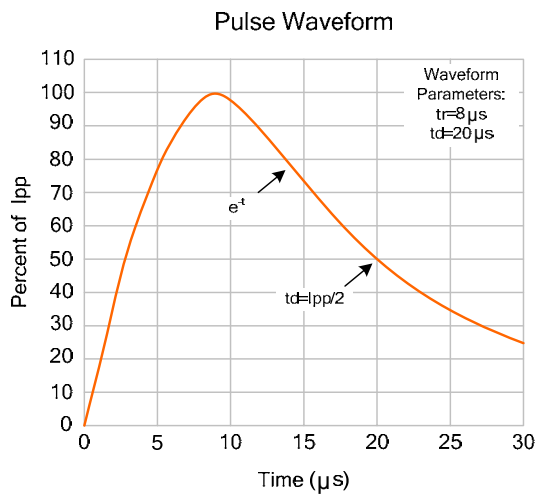
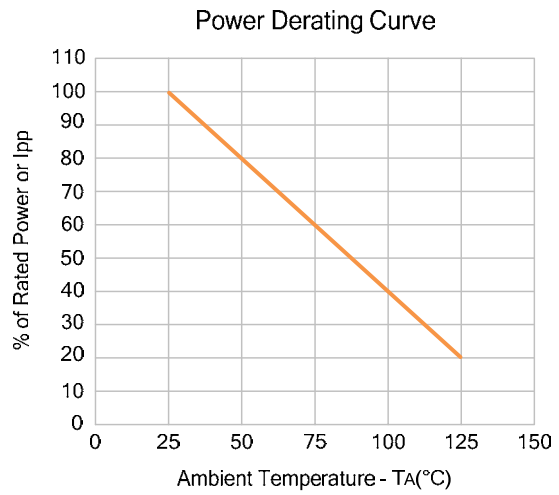
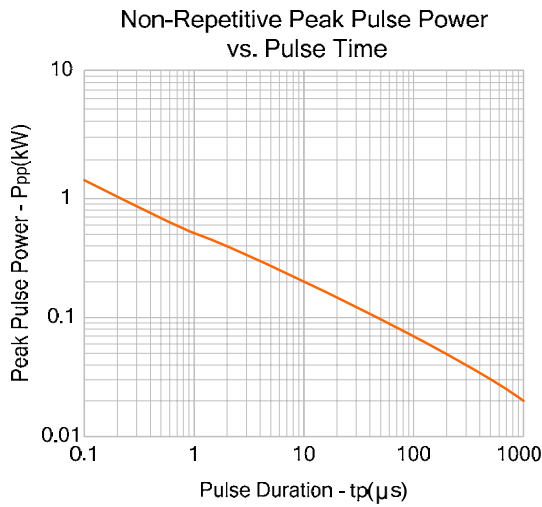
TYPICAL ELECTRICAL CHARACTERISTICS CURVE

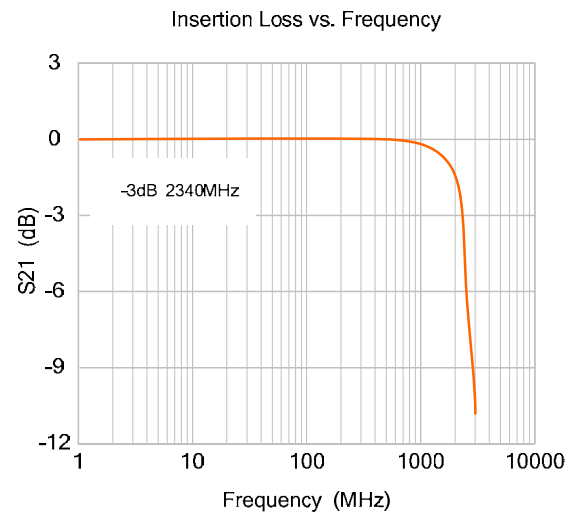
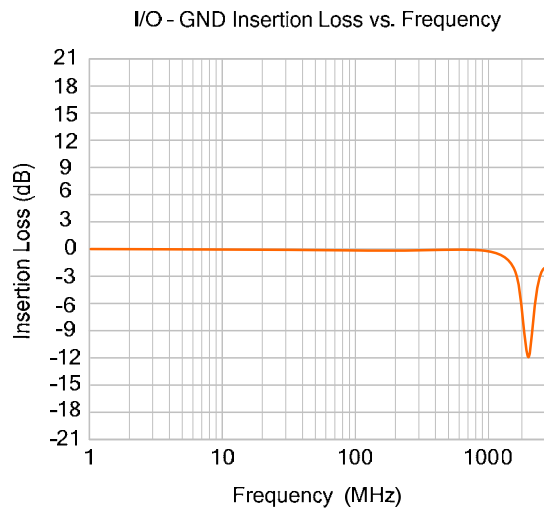

TYPICAL ELECTRICAL CHARACTERISTICS CURVE

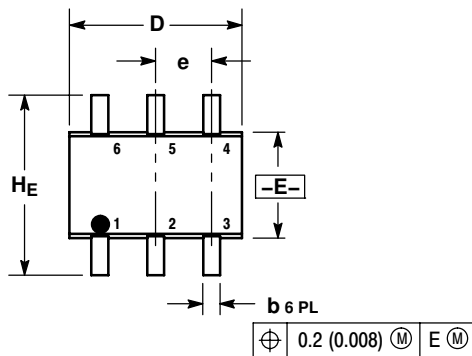
SC-88/SOT-363

NOTES:

1. DIMENSIONING AND TOLERANCING PER ANSI Y14.5M, 1982.
2. CONTROLLING DIMENSION: INCH.
3. 419B-01 OBSOLETE, NEW STANDARD 419B-02.

DIM	MILLIMETERS			INCHES		
	MIN	NOM	MAX	MIN	NOM	MAX
A	0.80	0.95	1.10	0.031	0.037	0.043
A1	0.00	0.05	0.10	0.000	0.002	0.004
A3	0.20 REF			0.008 REF		
b	0.10	0.21	0.30	0.004	0.008	0.012
C	0.10	0.14	0.25	0.004	0.005	0.010
D	1.80	2.00	2.20	0.070	0.078	0.086
E	1.15	1.25	1.35	0.045	0.049	0.053
e	0.65 BSC			0.026 BSC		
L	0.10	0.20	0.30	0.004	0.008	0.012
H _E	2.00	2.10	2.20	0.078	0.082	0.086

