

HYG170C03LR1S

30V Complementary MOSFET

Feature

N- Channel	P - Channel
Vds = 30V	Vds = -30V
9.5 A (Vgs= 10V)	- 8 A (Vgs= -10V)
12.9 mΩ (Vgs= 10V)	21.6 mΩ (Vgs= -10V)
19.3 mΩ (Vgs= 4.5V)	40.0 mΩ (Vgs= -4.5V)
<ul style="list-style-type: none"> ● 100% Avalanche Tested ● Reliable and Rugged ● Halogen Free and Green Devices Available (RoHS Compliant) 	

Pin Description

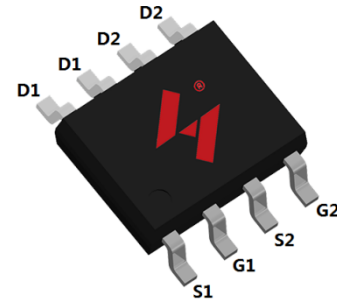

SOP8L

Applications

- Synchronous Rectifiers
- Wireless Power
- H-bridge Motor Drive

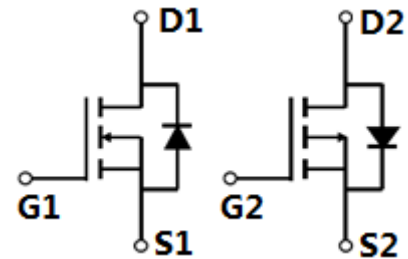

N-Channel

P-Channel

Ordering and Marking Information

 S G170C03 XYMXXXXXX	Package Code S: SOP8L Date Code XYMXXXXXX
--	--

Note: HUAYI lead-free products contain molding compounds/die attach materials and 100% matte tin plate termination finish, which are fully compliant with RoHS. HUAYI lead-free products meet or exceed the lead-free requirements of IPC/JEDEC J-STD-020 for MSL classification at lead-free peak reflow temperature. HUAYI defines "Green" to mean lead-free (RoHS compliant) and halogen free (Br or Cl does not exceed 900ppm by weight in homogeneous material and total of Br and Cl does not exceed 1500ppm by weight).

HUAYI reserves the right to make changes, corrections, enhancements, modifications, and improvements to this product and/or to this document at any time without notice.

Absolute Maximum Ratings

Symbol	Parameter	N- Channel	P- Channel	Unit	
Common Ratings (Tc=25°C Unless Otherwise Noted)					
V _{DSS}	Drain-Source Voltage	30	-30	V	
V _{GSS}	Gate-Source Voltage	±20		V	
T _J	Junction Temperature Range	-55 to 175		°C	
T _{STG}	Storage Temperature Range	-55 to 175		°C	
I _S	Source Current-Continuous(Body Tc=25°C)	9.5	-8	A	
Mounted on Large Heat Sink					
I _{DM}	Pulsed Drain Current *	Tc=25°C	38	-32	A
I _D	Continuous Drain Current	Tc=25°C	9.5	-8	A
		Tc=100°C	7.6	-5.6	A
P _D	Maximum Power Dissipation	Tc=25°C	3.0	3.0	W
		Tc=100°C	1.5	1.5	W
R _{QA}	Thermal Resistance, Junction-to-Ambient	50	50	°C/W	
E _{AS}	SinglePulsed-Avalanche Energy **	L=0.3mH	16.9	50	mJ

Note: * Repetitive rating; pulse width limited by max.junction temperature.

** Limited by T_{Jmax} , starting T_J=25°C, L = 0.3mH, R_G= 25Ω, V_{GS} =10V (N- Channel) /V_{GS} =-10V (P-Channel) .

N-Mosfet Electrical Characteristics (Tc =25°C Unless Otherwise Noted)

Symbol	Parameter	Test Conditions	HYG170C03LR1			Unit
			Min	Typ.	Max	
Static Characteristics						
BV _{DSS}	Drain-Source Breakdown Voltage	V _{GS} =0V, I _{DS} =250μA	30	-		V
I _{DSS}	Drain-to-Source Leakage Current	V _{DS} =30V, V _{GS} =0V	-	-	1	μA
		T _J =125°C	-	-	50	μA
V _{GS(th)}	Gate Threshold Voltage	V _{DS} =V _{GS} , I _{DS} =250μA	1	1.8	3	V
I _{GSS}	Gate-Source Leakage Current	V _{GS} =±20V, V _{DS} =0V	-	-	±100	nA
R _{DS(ON)*}	Drain-Source On-State Resistance	V _{GS} =10V, I _{DS} =6A	-	12.9	16.5	mΩ
		V _{GS} =4.5V, I _{DS} =4A		19.3	24.5	
Diode Characteristics						
V _{SD*}	Diode Forward Voltage	I _{SD} =1A, V _{GS} =0V	-	0.7	1.0	V
t _{rr}	Reverse Recovery Time	I _{SD} =6A, dI _{SD} /dt=100A/μs	-	10	-	ns
Q _{rr}	Reverse Recovery Charge		-	21	-	nC

N-Mosfet Electrical Characteristics (Cont.) (Tc =25°C Unless Otherwise Noted)

Symbol	Parameter	Test Conditions	HYG170C03LR1			Unit
			Min	Typ.	Max	
Dynamic Characteristics						
R _G	Gate Resistance	V _{GS} =0V, V _{DS} =0V, Frequency=1.0MHz	-	1.1	-	Ω
C _{iss}	Input Capacitance	V _{GS} =0V, V _{DS} =25V, Frequency=1.0MHz	-	446	-	pF
C _{oss}	Output Capacitance		-	55.1	-	
C _{rss}	Reverse Transfer Capacitance		-	44.2	-	
t _{d(ON)}	Turn-on Delay Time	V _{DD} =10V, R _G =4Ω, I _{DS} =6A, V _{GS} =10V	-	4.8	-	ns
T _r	Turn-on Rise Time		-	8.5	-	
t _{d(OFF)}	Turn-off Delay Time		-	16.5	-	
T _f	Turn-off Fall Time		-	5.6	-	
Gate Charge Characteristics						
Q _g	Total Gate Charge (V _{GS} =10V,)	V _{DS} =24V, I _D =6A	-	13.7	-	nC
Q _g	Total Gate Charge (V _{GS} =4.5V)		-	6.3	-	
Q _{gs}	Gate-Source Charge		-	1.1	-	
Q _{gd}	Gate-Drain Charge		-	3.0	-	

Note: *Pulse test, pulse width ≤ 300us, duty cycle ≤ 2%

N-Mosfet Typical Operating Characteristics

Figure 1: Power Dissipation

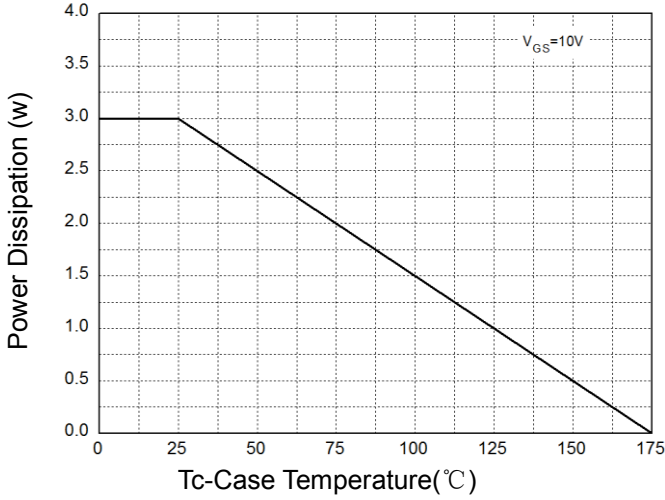

Figure 2: Drain Current

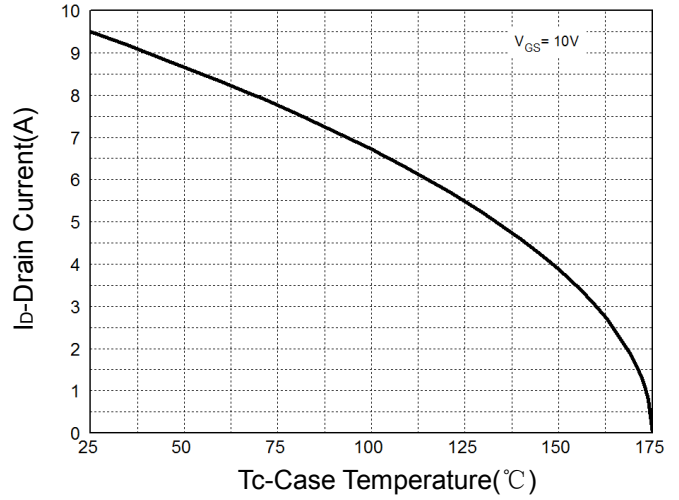

Figure 3: Safe Operation Area

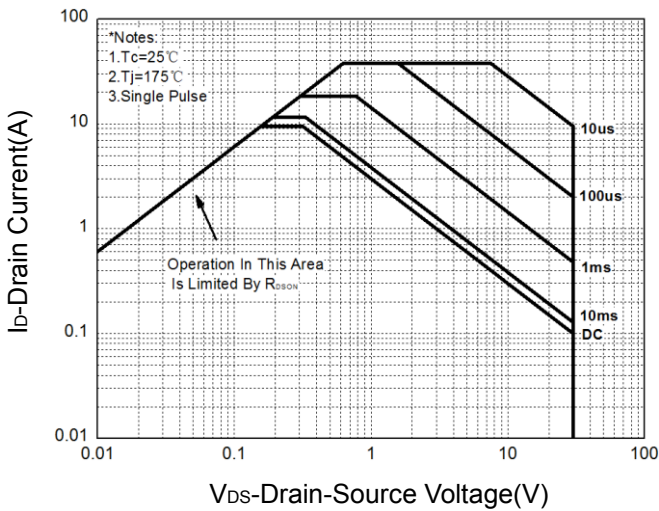

Figure 4: Thermal Transient Impedance

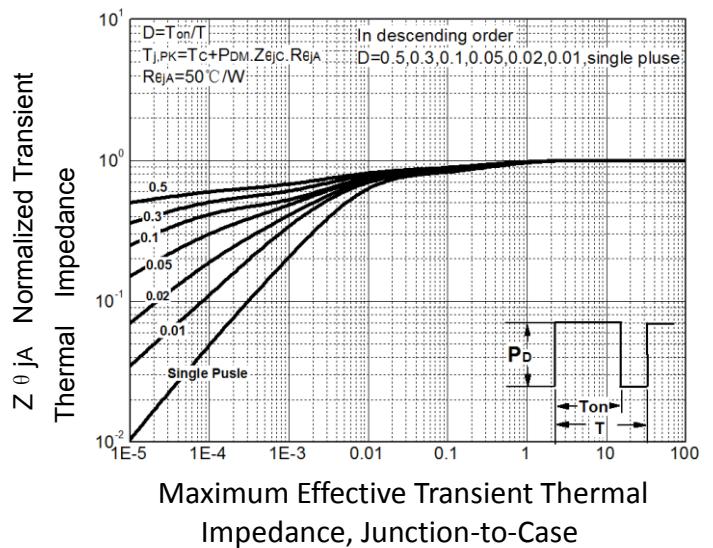

Figure 5: Output Characteristics

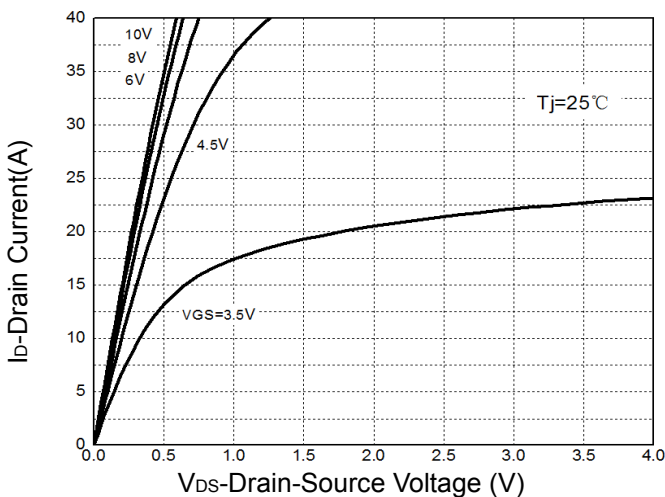
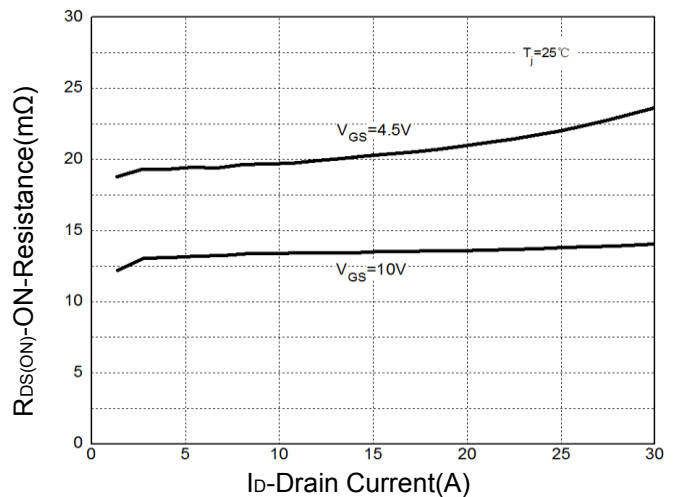

Figure 6: Drain-Source On Resistance



N-Mosfet Typical Operating Characteristics

Figure 7: On-Resistance vs. Temperature

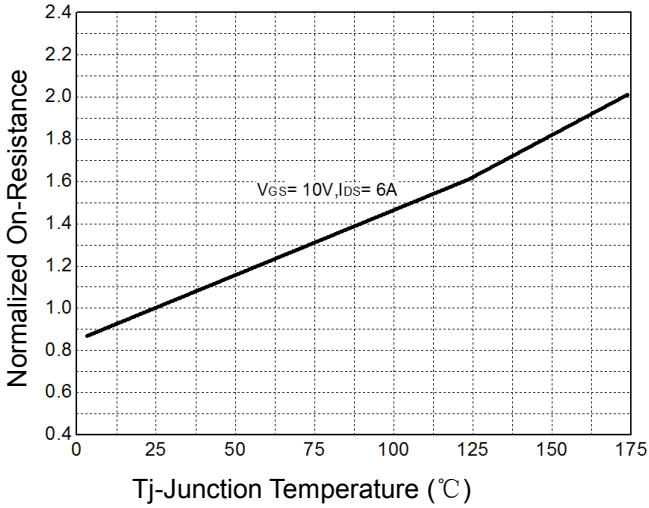

Figure 8: Source-Drain Diode Forward

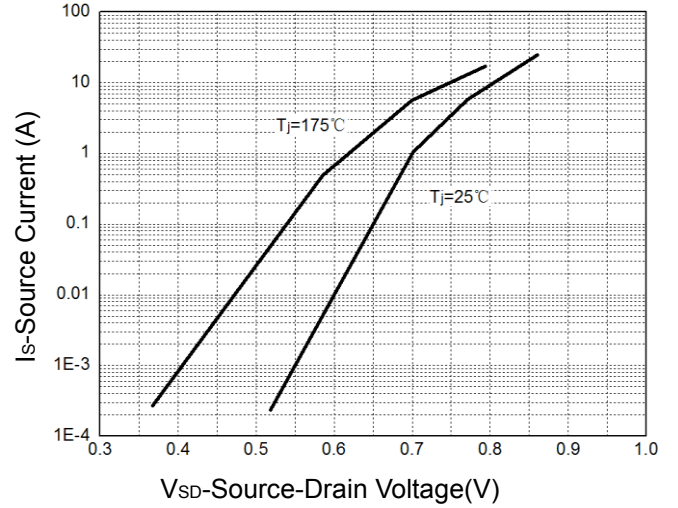

Figure 9: Capacitance Characteristics

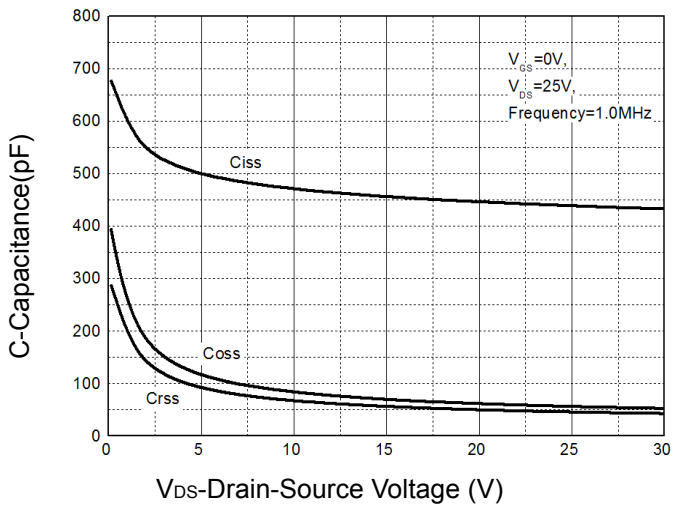
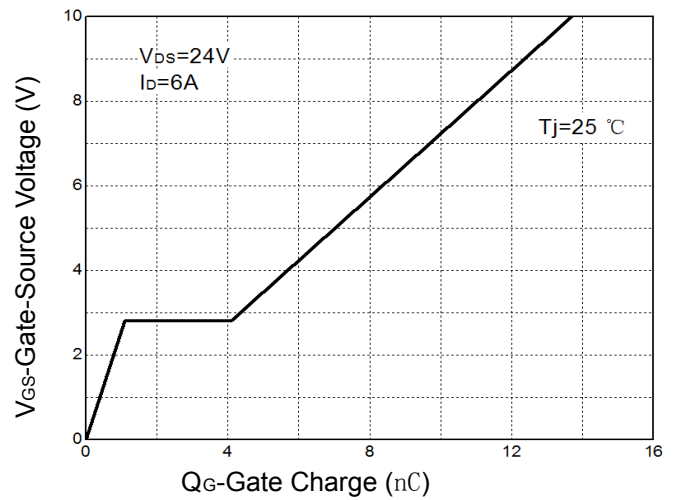
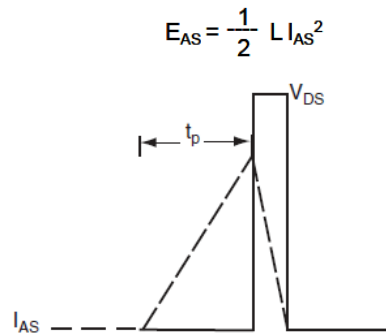
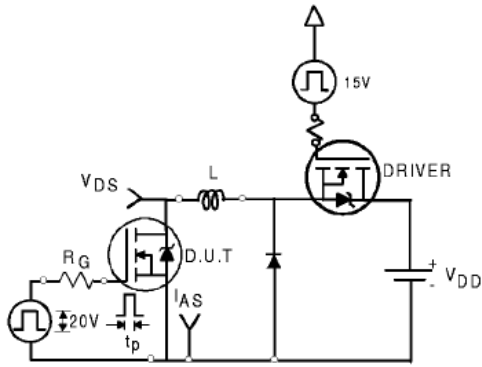

Figure 10: Gate Charge Characteristics



HYG170C03LR1S

Avalanche Test Circuit



Switching Time Test Circuit

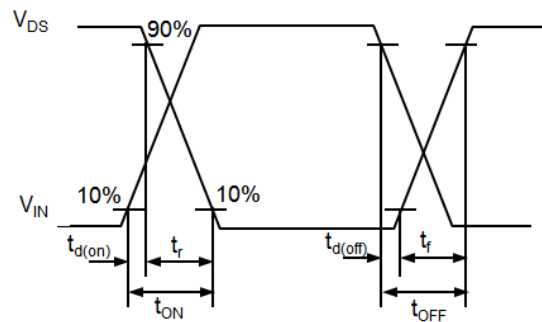
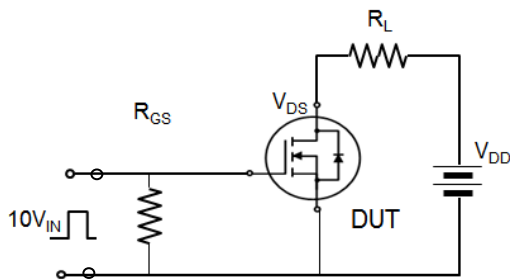

Gate Charge Test Circuit

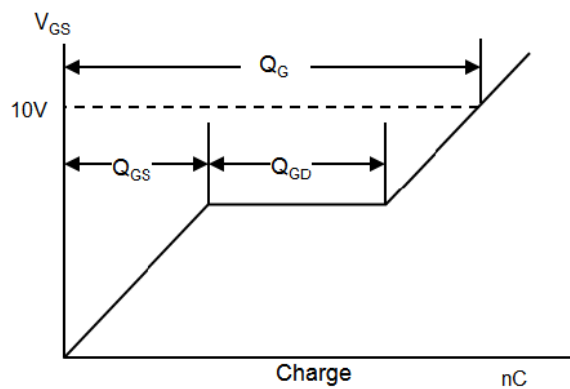
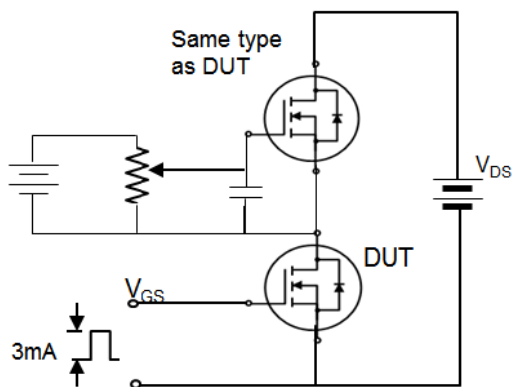

P-Mosfet Electrical Characteristics (T_c =25°C Unless Otherwise Noted)

Symbol	Parameter	Test Conditions	HYG170C03LR1			Unit
			Min	Typ.	Max	
Static Characteristics						
B _{VDS}	Drain-Source Breakdown Voltage	V _{GS} =0V, I _{DS} =-250μA	- 30	-		V
I _{DSS}	Drain-to-Source Leakage Current	V _{DS} =-30V, V _{GS} =0V		-	-1	μA
		T _J =125°C		-	-50	μA
V _{GS(th)}	Gate Threshold Voltage	V _{DS} =V _{GS} , I _{DS} =-250μA	-1	-1.9	-3	V
I _{GSS}	Gate-Source Leakage Current	V _{GS} =± 20V, V _{DS} =0V	-	-	±100	nA
R _{DS(ON)*}	Drain-Source On-State Resistance	V _{GS} =-10V, I _{DS} =-6A	-	21.6	30	mΩ
		V _{GS} =-4.5V, I _{DS} =-4A		40.0	55	
Diode Characteristics						
V _{SD*}	Diode Forward Voltage	I _{SD} =-1A, V _{GS} =0V	-	-0.7	-1	V
t _{rr}	Reverse Recovery Time	I _{SD} =-3A, dI _{SD} /dt=100A/μs	-	29	-	ns
Q _{rr}	Reverse Recovery Charge		-	12	-	nC

P-Mosfet Electrical Characteristics (Cont.) (T_c =25°C Unless Otherwise Noted)

Symbol	Parameter	Test Conditions	HYG170C03LR1			Unit
			Min	Typ.	Max	
Dynamic Characteristics						
R _G	Gate Resistance	V _{GS} =0V, V _{DS} =0V, Frequency=1.0MHz	-	8.5	-	Ω
C _{iss}	Input Capacitance	V _{GS} =0V, V _{DS} =-25V, Frequency=1.0MHz	-	1210	-	pF
C _{oss}	Output Capacitance		-	120	-	
C _{rss}	Reverse Transfer Capacitance		-	86	-	
t _{d(ON)}	Turn-on Delay Time	V _{DD} =-10V, R _G =4Ω, I _{DS} =-6A, V _{GS} =-10V	-	8	-	ns
T _r	Turn-on Rise Time		-	5	-	
t _{d(OFF)}	Turn-off Delay Time		-	15	-	
T _f	Turn-off Fall Time		-	11	-	
Gate Charge Characteristics						
Q _g	Total Gate Charge(V _{GS} = -10V)	V _{DS} =-24V, I _D =-6A	-	18.5	-	nC
Q _g	Total Gate Charge(V _{GS} = -4.5V)			10.2		
Q _{gs}	Gate-Source Charge		-	5.4	-	
Q _{gd}	Gate-Drain Charge		-	2.8	-	

Note: *Pulse test, pulse width ≤ 300us, duty cycle ≤ 2%

P-Mosfet Typical Operating Characteristics

Figure 1: Power Dissipation

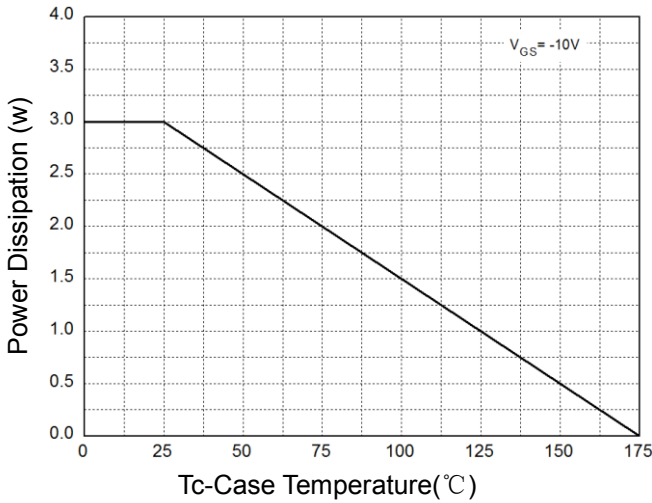

Figure 2: Drain Current

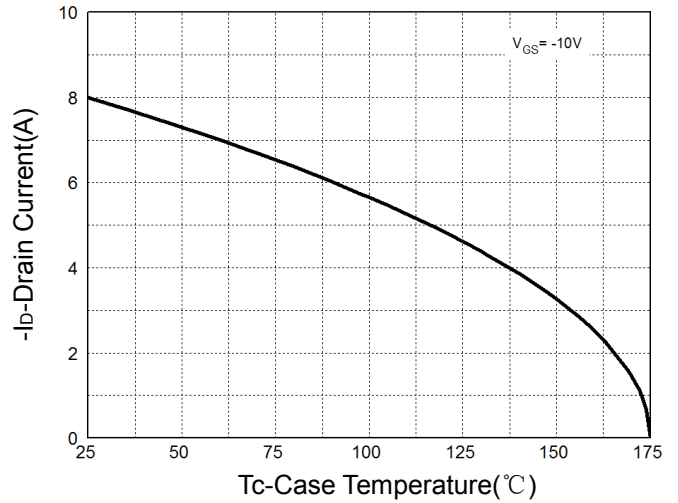

Figure 3: Safe Operation Area

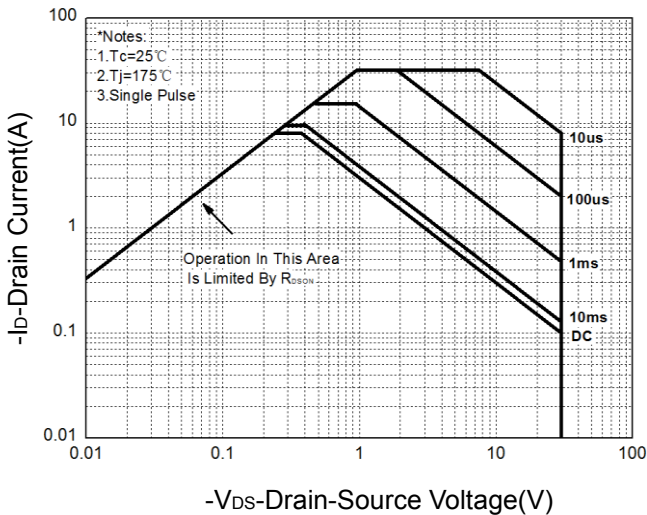
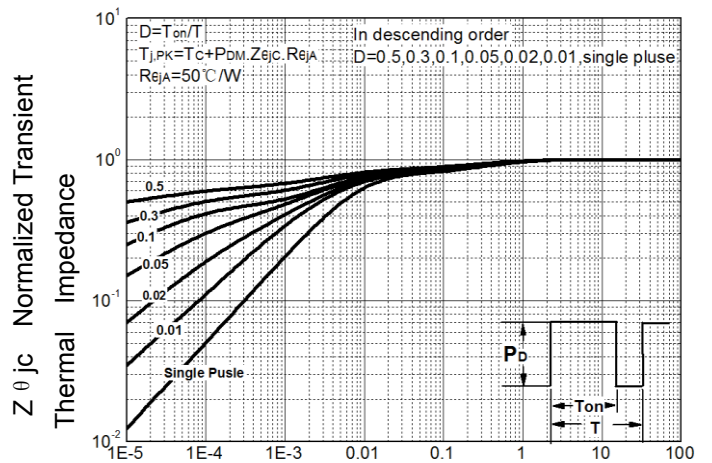

Figure 4: Thermal Transient Impedance



Maximum Effective Transient Thermal Impedance, Junction-to-Case

Figure 5: Output Characteristics

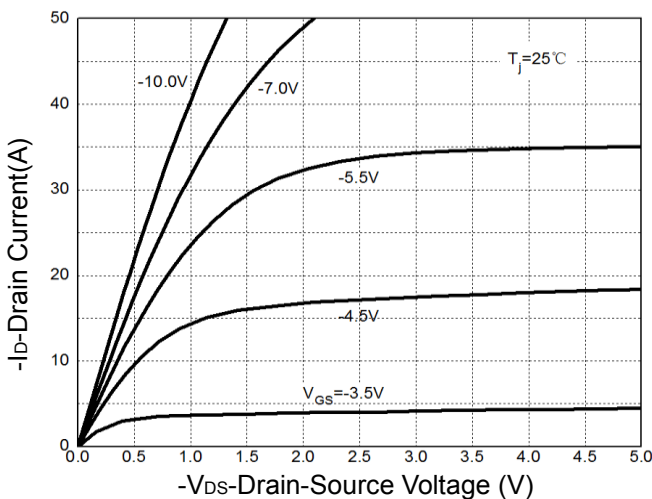
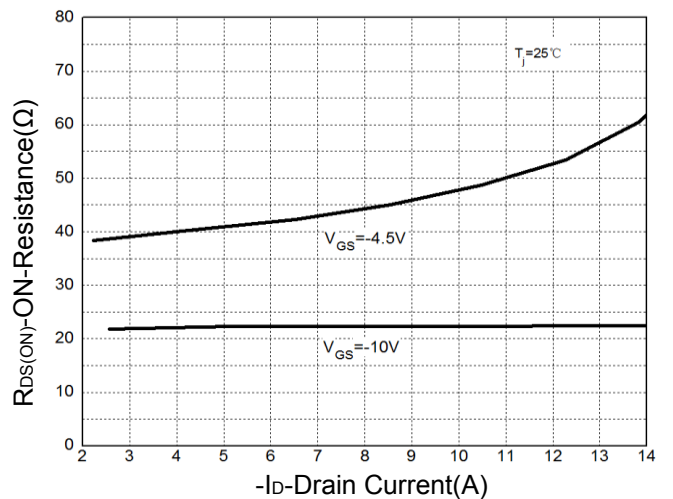

Figure 6: Drain-Source On Resistance



P-Mosfet Typical Operating Characteristics

Figure 7: On-Resistance vs. Temperature

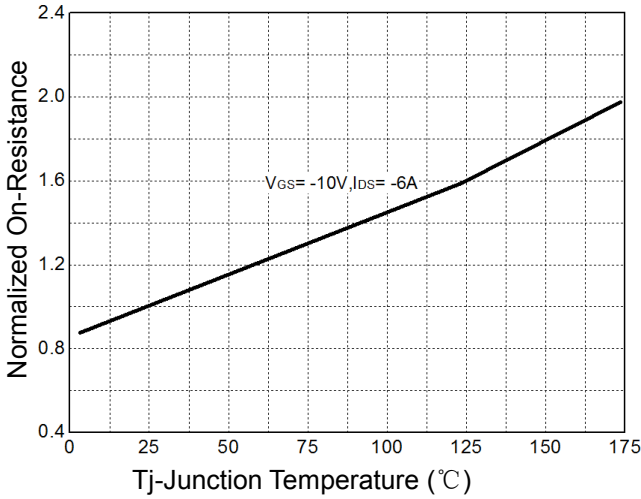

Figure 8: Source-Drain Diode Forward

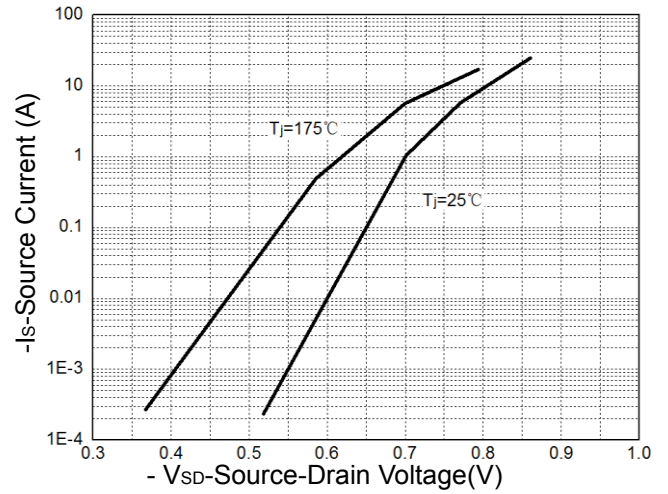

Figure 9: Capacitance Characteristics

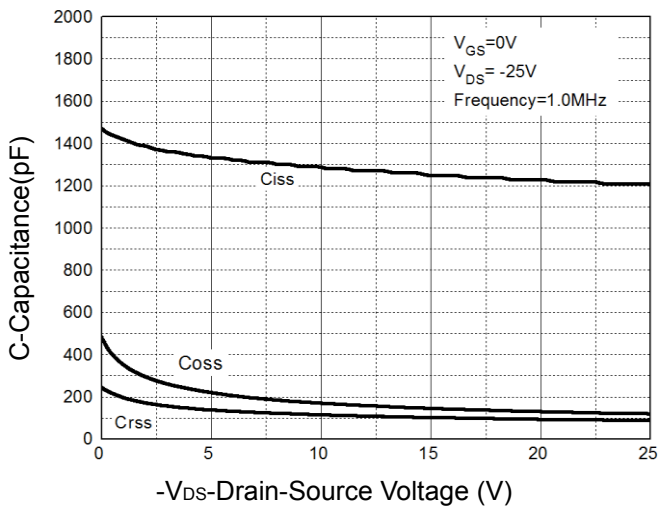
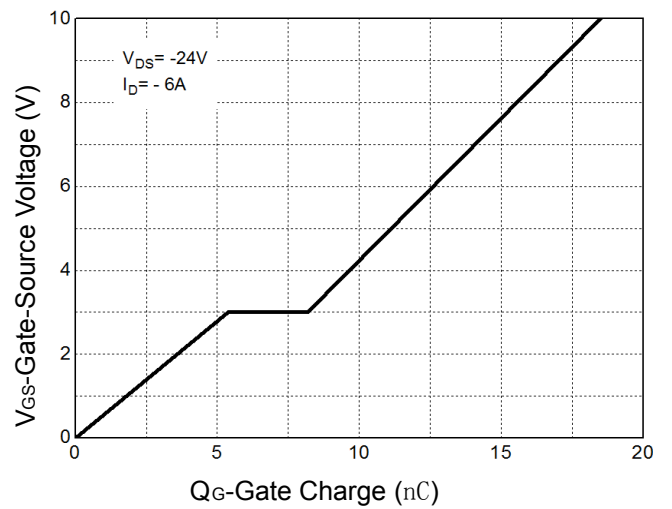
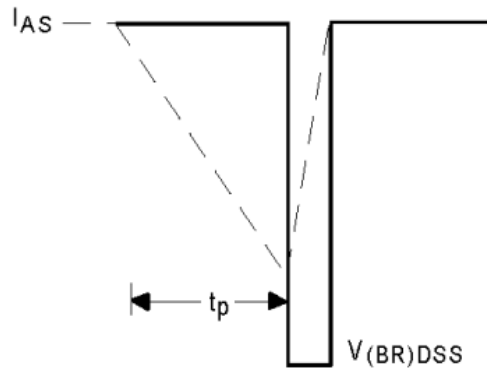
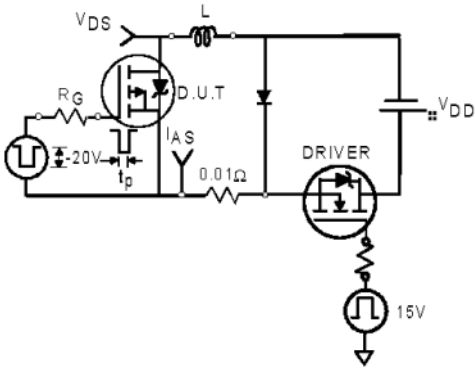

Figure 10: Gate Charge Characteristics



Avalanche Test Circuit



Switching Time Test Circuit

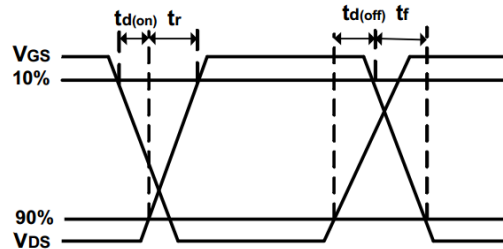
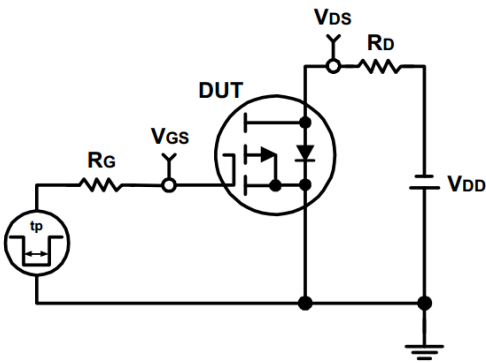

Gate Charge Test Circuit

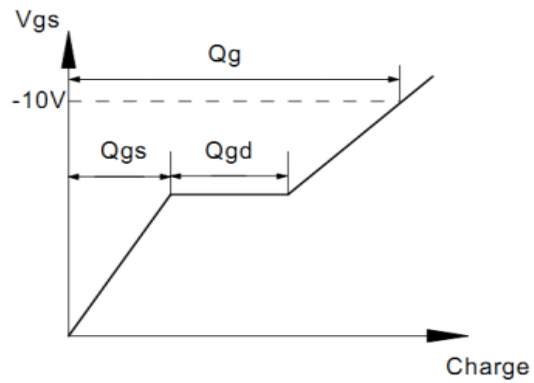
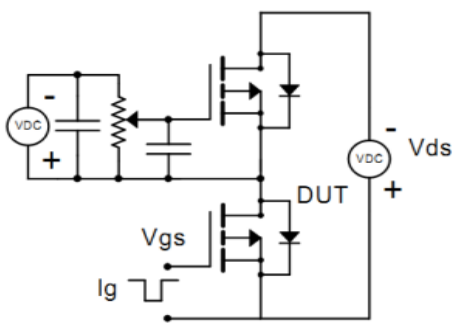

Device Per Unit

Package Type	Unit	Quantity
SOP8L	Reel	2500

Package Information

SOP8L

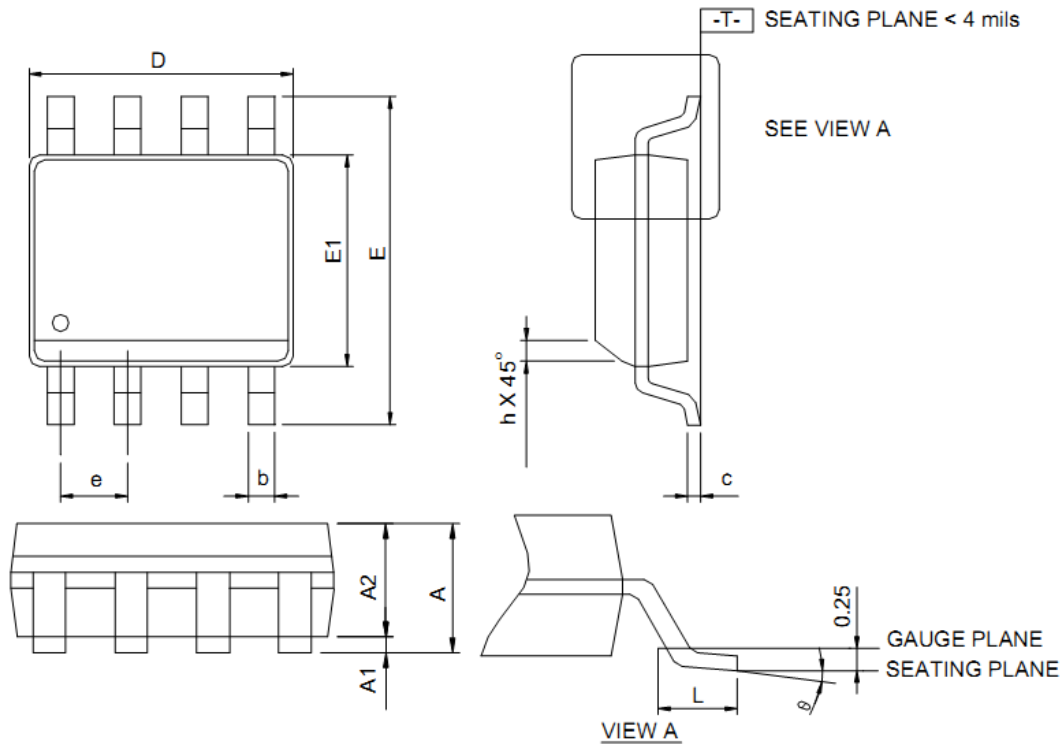

DIMENSIONS	SOP8L			
	MILLIMETERS		INCHES	
	MIN.	MAX.	MIN.	MAX.
A	-	1.75	-	0.069
A1	0.10	0.25	0.004	0.010
A2	1.25	-	0.049	-
b	0.31	0.51	0.012	0.020
c	0.17	0.25	0.007	0.010
D	4.80	5.00	0.189	0.197
E	5.80	6.20	0.228	0.244
E1	3.80	4.00	0.150	0.157
e	1.27 BSC		0.050 BSC	
h	0.25	0.50	0.010	0.020
L	0.40	1.27	0.016	0.050
theta	0°	8°	0°	8°

RECOMMENDED LAND PATTERN

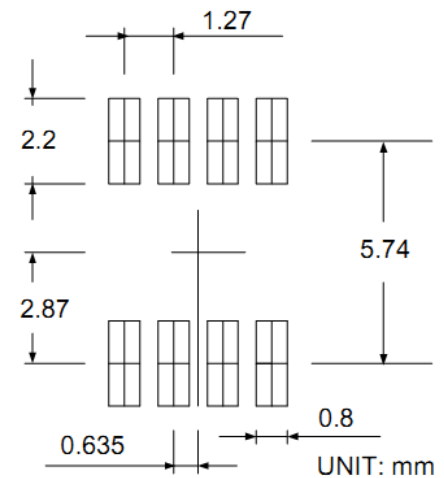

Note: 1. Follow JEDEC MS-012 AA.

2. Dimension "D" does not include mold flash, protrusions or gate burrs. Mold flash, protrusion or gate burrs shall not exceed 6 mil per side.

3. Dimension "E" does not include inter-lead flash or protrusions. Inter-lead flash and protrusions shall not exceed 10 mil per side.

HYG170C03LR1S

Carrier Tape & Reel Dimensions

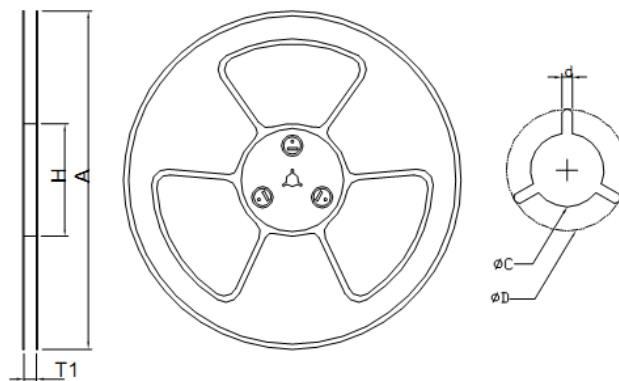
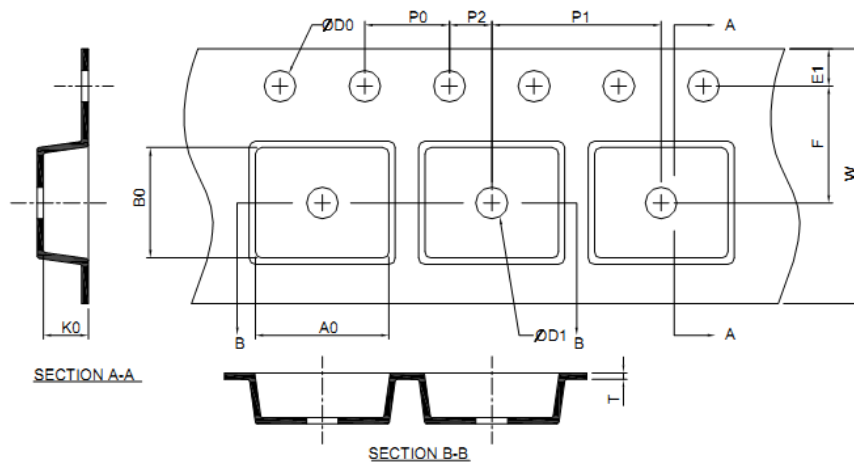

Application	A	H	T1	C	d	D	W	E1	F
SOP8L	330.0 2.00	50 MIN.	12.4+2.00 -0.00	13.0+0.50 -0.20	1.5 MIN.	20.2 MIN.	12.0 0.30	1.75 0.10	5.5 0.05
	P0	P1	P2	D0	D1	T	A0	B0	K0
	4.0 0.10	8.0 0.10	2.0 0.05	1.5+0.10 -0.00	1.5 MIN.	0.6+0.00 -0.40	6.40 0.20	5.20 0.20	2.10 0.20

(mm)

Taping Direction Information

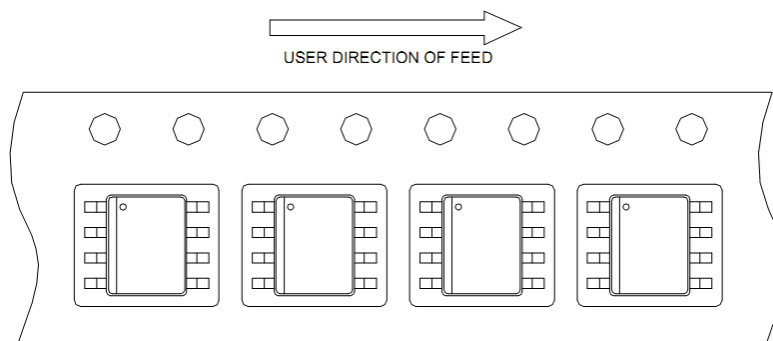

Classification Profile

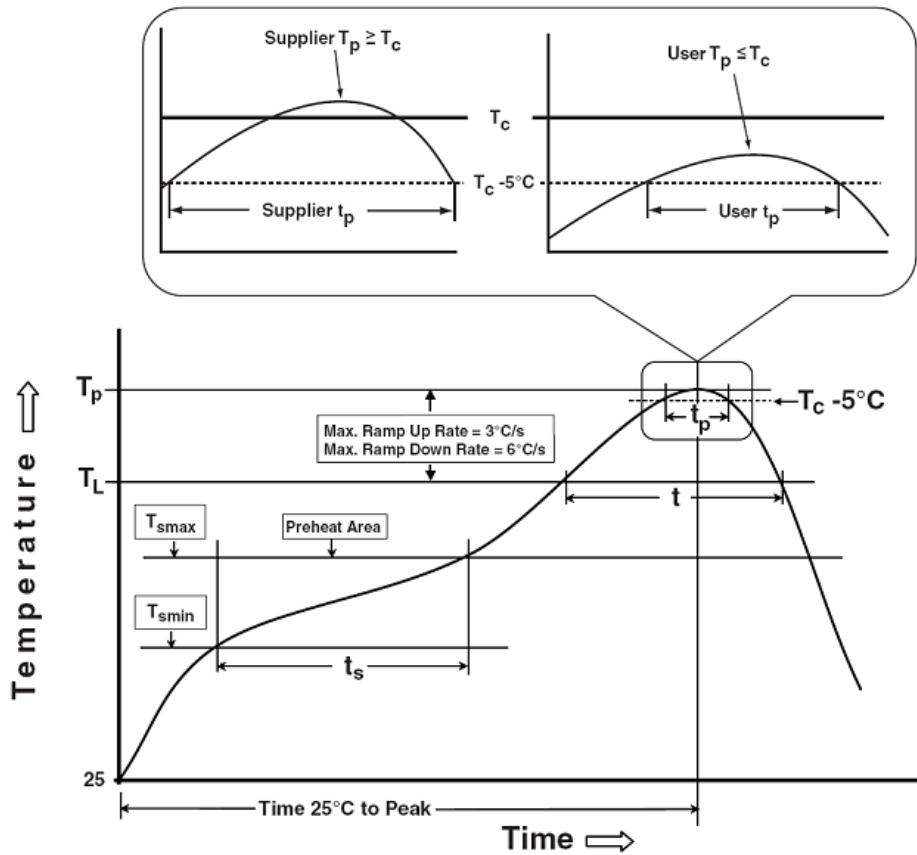

Classification Reflow Profiles

Profile Feature	Sn-Pb Eutectic Assembly	Pb-Free Assembly
Preheat & Soak		
Temperature min (T_{smin})	100 °C	150 °C
Temperature max (T_{smax})	150 °C	200 °C
Time (T_{smin} to T_{smax}) (t_s)	60-120 seconds	60-120 seconds
Average ramp-up rate (T_{smax} to T_P)	3 °C/second max.	3 °C/second max.
Liquidous temperature (T_L)	183 °C	217 °C
Time at liquidous (t_L)	60-150 seconds	60-150 seconds
Peak package body Temperature (T_p)*	See Classification Temp in table 1	See Classification Temp in table 2
Time (t_p)** within 5°C of the specified classification temperature (T_c)	20** seconds	30** seconds
Average ramp-down rate (T_p to T_{smax})	6 °C/second max.	6 °C/second max.
Time 25°C to peak temperature	6 minutes max.	8 minutes max.
*Tolerance for peak profile Temperature (T_p) is defined as a supplier minimum and a user maximum.		
** Tolerance for time at peak profile temperature (t_p) is defined as a supplier minimum and a user maximum.		

Table 1.SnPb Eutectic Process – Classification Temperatures (Tc)

Package Thickness	Volume mm ³ <350	Volume mm ³ ≥350
<2.5 mm	235 °C	220 °C
≥2.5 mm	220 °C	220 °C

Table 2.Pb-free Process – Classification Temperatures (Tc)

Package Thickness	Volume mm ³ <350	Volume mm ³ 350-2000	Volume mm ³ ≥2000
<1.6 mm	260 °C	260 °C	260 °C
1.6 mm – 2.5 mm	260 °C	250 °C	245 °C
≥2.5 mm	250 °C	245 °C	245 °C

Reliability Test Program

Test item	Method	Description
SOLDERABILITY	JESD-22, B102	5 Sec, 245°C
HTRB	JESD-22, A108	168 Hrs \ 500Hrs\ 1000 Hrs, Bias @ 125°C
PCT	JESD-22, A102	96 Hrs, 100%RH, 2atm, 121°C
TCT	JESD-22, A104	500 Cycles, -55°C~150°C

Customer Service

Worldwide Sales and Service: sales@hymexa.com

Technical Support: Technology@hymexa.com

Huayi Microelectronics Co., Ltd.

No.8928,Shangji Road,Economic and Technological Development Zone,Xi'an,China

TEL: (86-029) 86685706

FAX: (86-029) 86685705

E-mail: sales@hymexa.com

Web net: www.hymexa.com