



## LM358

## LINEAR INTEGRATED CIRCUIT

### DUAL OPERATIONAL AMPLIFIER

#### DESCRIPTION

The UTC LM358 consists of two independent high gain, internally frequency compensated operational amplifier. It can be operated from a single power supply and also split power supplies.

#### FEATURES

- \*Internally frequency compensated for unity gain.
- \*Wide power supply range 3V - 32V.
- \*Input common-mode voltage range include ground.
- \*Large DC voltage gain.

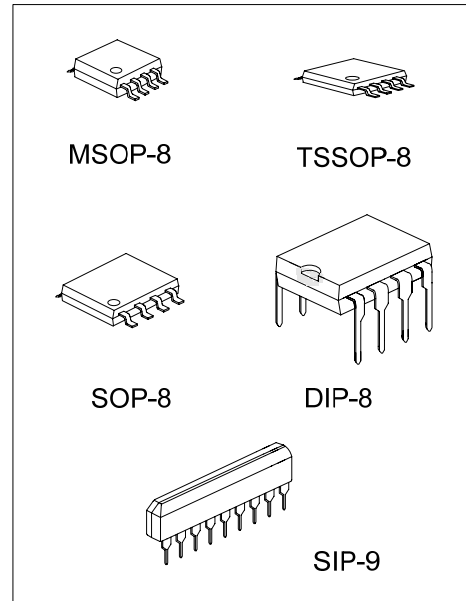

\*Pb-free plating product number: LM358L

#### ORDERING INFORMATION

Ordering Number		Package	Packing
Normal	Lead Free Plating		
LM358-D08-T	LM358L-D08-T	DIP-8	Tube
LM358-G09-T	LM358L-G09-T	SIP-9	Tube
LM358-P08-R	LM358L-P08-R	TSSOP-8	Tape Reel
LM358-P08-T	LM358L-P08-T	TSSOP-8	Tube
LM358-S08-R	LM358L-S08-R	SOP-8	Tape Reel
LM358-S08-T	LM358L-S08-T	SOP-8	Tube
LM358-SM1-R	LM358L-SM1-R	MSOP-8	Tape Reel
LM358-SM1-T	LM358L-SM1-T	MSOP-8	Tube

<p>LM358L-D08-T</p> <p>(1) Packing Type (2) Package Type (3) Lead Plating</p>	<p>(1) R: Tape Reel, T: Tube (2) D08: DIP-8, G09: SIP-9, S08: SOP-8, SM1: MSOP-8, P08: TSSOP-8 (3) L: Lead Free Plating, Blank: Pb/Sn</p>
---	---

### ■ PIN DESCRIPTION

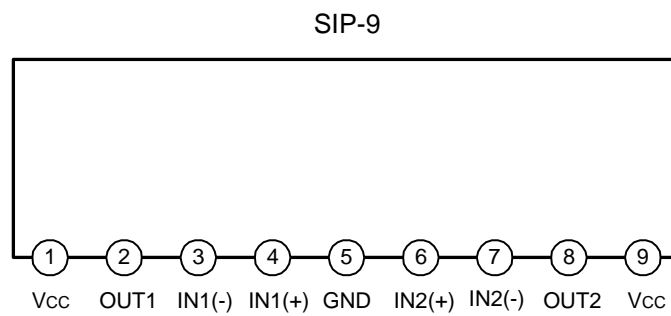
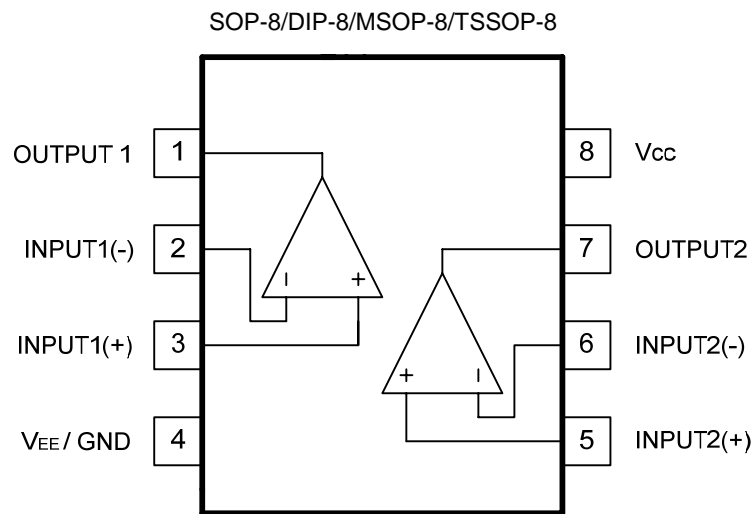

## ■ BLOCK DIAGRAM

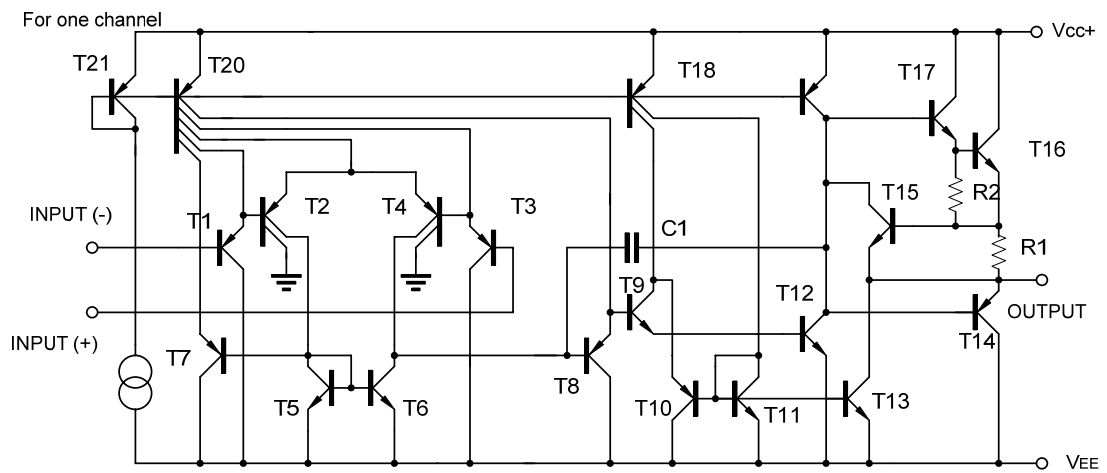

■ ABSOLUTE MAXIMUM RATINGS

PARAMETER		SYMBOL	RATINGS	UNIT
Supply Voltage		$V_{CC}$	$\pm 16$ or 32	V
Differential Input Voltage		$V_{I(DIFF)}$	$\pm 32$	V
Input Voltage		$V_I$	-0.3 ~ +32	V
Output Short to Ground			Continuous	
Power Dissipation	SIP-9	$P_D$	600	mW
	DIP-8		500	
	SOP-8		280	
	TSSOP-8/MSOP-8		200	
Junction Temperature		$T_J$	+125	°C
Operating Temperature		$T_{OPR}$	0 ~ +70	°C
Storage Temperature		$T_{STG}$	-65 ~ +150	°C

Note Absolute maximum ratings are those values beyond which the device could be permanently damaged. Absolute maximum ratings are stress ratings only and functional device operation is not implied.

■ ELECTRICAL CHARACTERISTICS ( $V_{CC}=5.0V$ ,  $V_{EE}=GND$ ,  $T_a=25^\circ C$ , unless otherwise specified)

PARAMETER	SYMBOL	TEST CONDITIONS	MIN	TYP	MAX	UNIT
Input Offset Voltage	$V_{I(OFF)}$	$V_{CM}=0V$ to $V_{CC}-1.5V$ $V_{O(P)}=1.4V$ , $R_S=0\Omega$		2.9	7.0	mV
Input Common Mode Voltage	$V_{I(CM)}$	$V_{CC}=30V$	0		$V_{CC}-1.5$	V
Differential Input Voltage	$V_{I(DIFF)}$				$V_{CC}$	V
Output Voltage Swing	$V_{OH}$	$V_{CC}=30V$ , $R_L=2K\Omega$	26			V
		$V_{CC}=30V$ , $R_L=10K\Omega$	27	28		V
	$V_{OL}$	$V_{CC}=5V$ , $R_L \geq 10K\Omega$		5	20	mV
Large Signal Voltage Gain	$G_V$	$V_{CC}=15V$ , $R_L \geq 2K\Omega$ $V_{O(P)}=1V \sim 11V$	25	100		V/mV
Power Supply Current	$I_{CC}$	$R_L=\infty$ , $V_{CC}=30V$		0.8	2.0	mA
		$R_L=\infty$ , Full Temperature Range		0.5	1.2	mA
Input Offset Current	$I_{I(OFF)}$			5	50	nA
Input Bias Current	$I_{I(BIAS)}$			45	250	nA
Short Circuit Current to Ground	$I_{SC}$			40	60	mA
Output Current	$I_{SOURCE}$	$V_I(+)=1V$ , $V_I(-)=0V$ $V_{CC}=15V$ , $V_{O(P)}=2V$	10	30		mA
		$V_I(+)=0V$ , $V_I(-)=1V$ $V_{CC}=15V$ , $V_{O(P)}=2V$	10	15		mA
	$I_{SINK}$	$V_I(+)=0V$ , $V_I(-)=1V$ $V_{CC}=15V$ , $V_{O(P)}=200mV$	12	100		mA
Common Mode Rejection Ratio	CMRR		65	80		dB
Power Supply Rejection Ratio	PSRR		65	100		dB
Channel Separation	CS	$f=1KHZ \sim 20KHZ$		120		dB

## TYPICAL CHARACTERISTICS

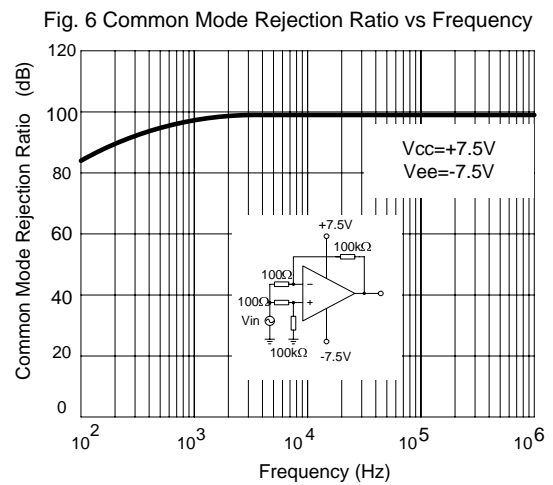
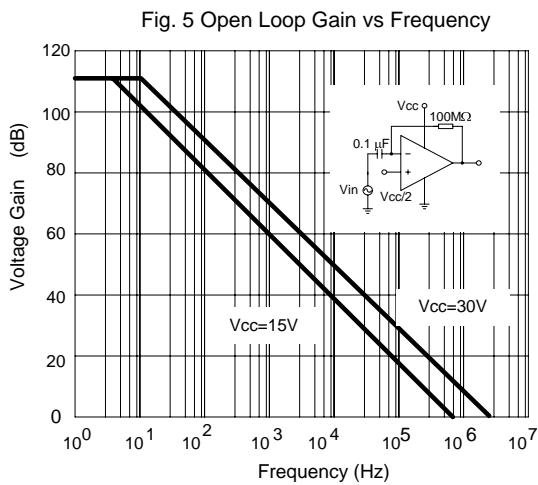
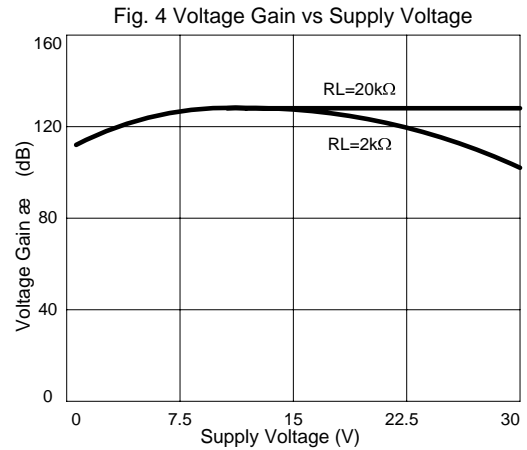
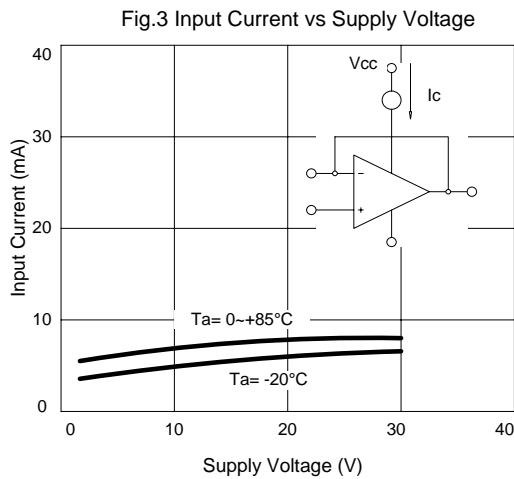
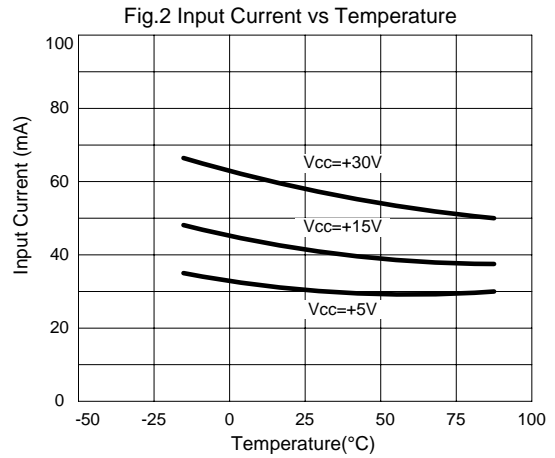
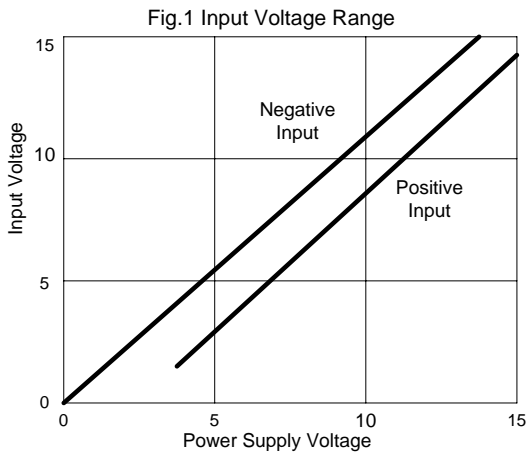

## TYPICAL CHARACTERISTICS(Cont.)

Fig. 7 Voltage Follower Pulse Response

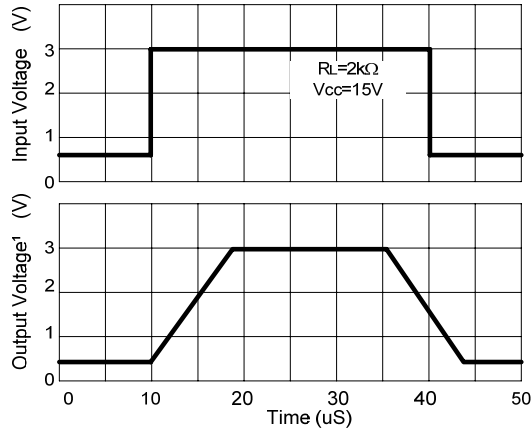

Fig. 8 Voltage Follower Response (Small Signal)

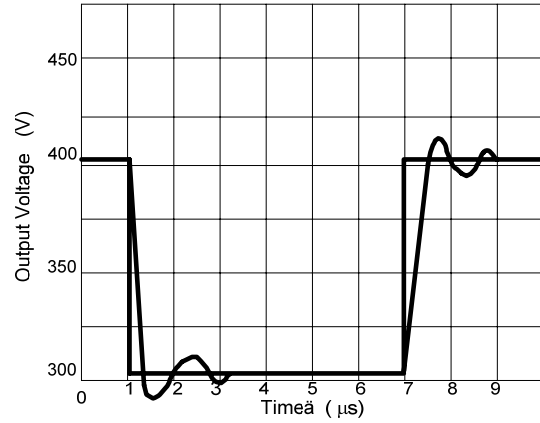

Fig. 9 Gain vs Large Signal Frequency

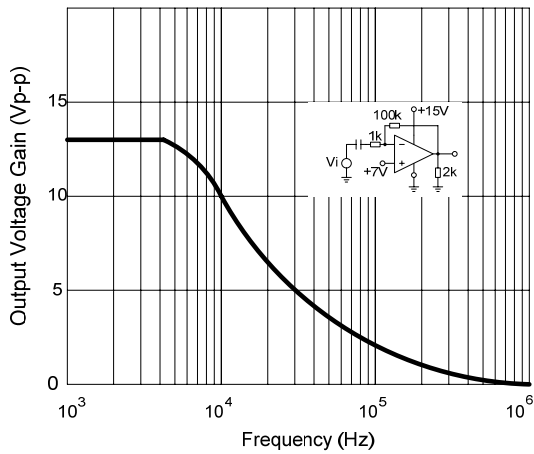

Fig. 10 Output Current Sinking vs Output Voltage

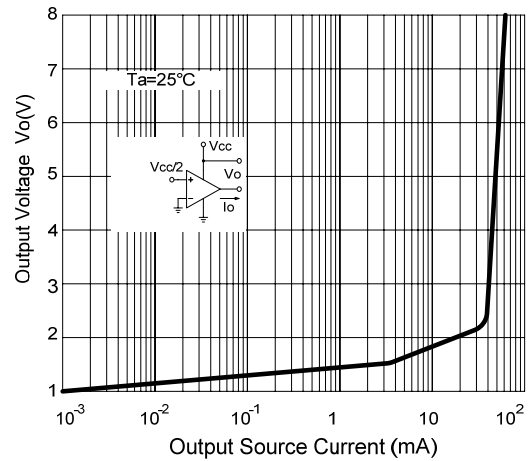

Fig. 11 Output Sink Current vs Output Voltage

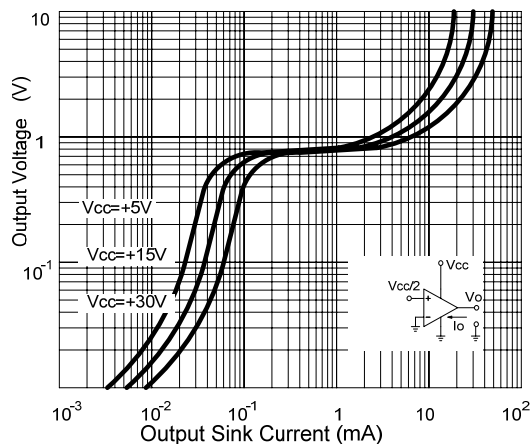
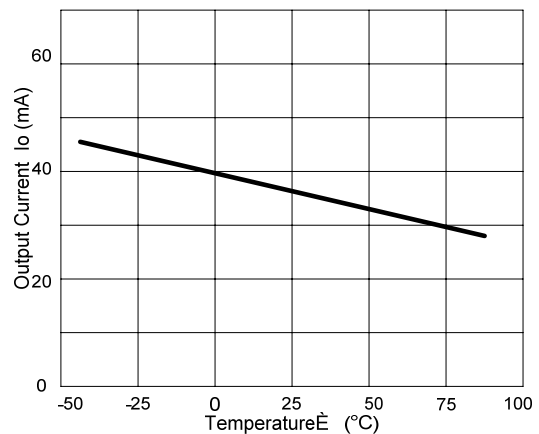

Fig.12 Current Limiting vs Temperature



UTC assumes no responsibility for equipment failures that result from using products at values that exceed, even momentarily, rated values (such as maximum ratings, operating condition ranges, or other parameters) listed in products specifications of any and all UTC products described or contained herein. UTC products are not designed for use in life support appliances, devices or systems where malfunction of these products can be reasonably expected to result in personal injury. Reproduction in whole or in part is prohibited without the prior written consent of the copyright owner. The information presented in this document does not form part of any quotation or contract, is believed to be accurate and reliable and may be changed without notice.