



Features

- Low on-resistance
- N-Channel MOSFET
- Low input capacitance
- Fast switching speed
- ESD Protection

Shipping Quantity

- 3000pcs / Tape & Reel

Typical Applications

- DC-DC converters
- Power management functions
- Battery operated systems and solid-state relays
- Drivers: Relays, Solenoids, Lamps, Hammers, Displays, Memories, Transistors, etc.

Mechanical Data

- Case: SOT-23
- Molding Compound, UL Flammability Classification Rating 94V-0
- Terminals: Matte Tin Plated Leads, Solderable Per MIL-STD-202, Method 208

SOT-23



1. GATE
2. SOURCE
3. DRAIN

Circuit Diagram

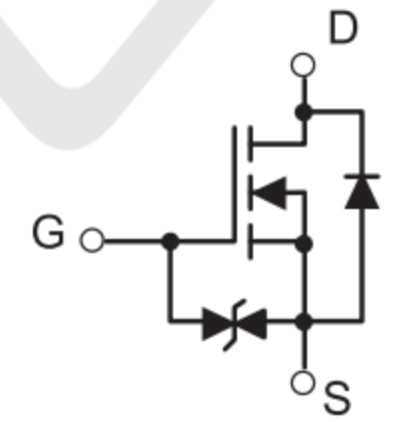

N-MOS

Marking: J2x

“J2” is Part number ,Fixed
“x” is internal code

Absolute Maximum Ratings (Tamb=25°C unless otherwise specified)

| Parameter | Symbol | Value | Units |
|---|-----------------|-------|-------|
| Drain-Source Voltage | V_{DSS} | 50 | V |
| Gate -Source Voltage | V_{GSS} | ±20 | V |
| Continuous Drain Current (T _A = 25°C) *1 | I_D | 360 | mA |
| Pulsed Drain Current (t _p = 10µs, T _A = 25°C) | I_{DM} | 1500 | mA |
| Single Pulse Avalanche Energy *2 | E_{AS} | 0.2 | mJ |
| Power Dissipation | SOT-23 P_D | 0.35 | W |



Thermal Characteristics

| Parameter | Symbol | Limits | Unit |
|--|-----------------|-------------|------|
| Thermal Resistance Junction to Ambient Air | $R_{\theta JA}$ | 370 | °C/W |
| Thermal Resistance Junction to Lead | $R_{\theta JL}$ | 222 | |
| Thermal Resistance Junction to Case | $R_{\theta JC}$ | 187 | |
| Operating Junction Temperature Range | T_J | -55 to +150 | °C |
| Storage Temperature Range | T_{STG} | -55 to +150 | °C |

Electrical Characteristics (TA=25°C unless otherwise specified)

| Symbol | Parameter | Test conditions | MIN | TYP | MAX | UNIT |
|---|---------------------------------|--|-----|------|----------|----------|
| OFF Characteristics | | | | | | |
| V_{DSS} | Drain-Source Breakdown Voltage | $V_{GS} = 0V, I_D = 250\mu A$ | 50 | - | - | V |
| I_{DSS} | Drain to Source Leakage Current | $V_{DS} = 50V, V_{GS} = 0V$ | - | - | 1 | μA |
| I_{GSS} | Gate-body Leakage | $V_{GS} = \pm 20V, V_{DS} = 0V$ | - | - | ± 10 | μA |
| ON Characteristics | | | | | | |
| $R_{DS(ON)}$ | Drain-Source On-resistance *1 | $V_{GS} = 10V, I_D = 0.5A$ | - | 1.5 | 2.0 | Ω |
| | | $V_{GS} = 4.5V, I_D = 0.2A$ | - | 1.7 | 2.5 | |
| | | $V_{GS} = 2.5V, I_D = 0.1A$ | - | 2.0 | 4.5 | |
| $V_{GS(TH)}$ | Gate Threshold Voltage | $V_{DS} = V_{GS}, I_D = 250\mu A$ | 0.8 | 1 | 1.5 | V |
| R_G | Gate Resistance | $V_{GS} = 0V, f = 1MHz$ | - | 48 | - | Ω |
| Dynamic Characteristics | | | | | | |
| C_{ISS} | Input Capacitance | $V_{GS} = 0V$ | - | 32 | - | pF |
| C_{OSS} | Output Capacitance | $V_{DS} = 25V$ | - | 6 | - | |
| C_{RSS} | Reverse Transfer Capacitance | $f = 1.0MHz$ | - | 3 | - | |
| Switching Characteristics | | | | | | |
| $t_{d(on)}$ | Turn-on Delay Time *3 | $V_{DD} = 25V, I_D = 0.36A$ $V_{GS} = 10V, R_G = 6\Omega$ | - | 2.2 | - | nS |
| t_r | Turn-on Rise Time *3 | | - | 19.2 | - | |
| $t_{d(off)}$ | Turn-Off Delay Time *3 | | - | 6.2 | - | |
| t_f | Turn-Off Fall Time *3 | | - | 23 | - | |
| Q_G | Total Gate-Charge | $V_{DS} = 25V$ | - | 4 | - | nC |
| Q_{GS} | Gate to Source Charge | $V_{GS} = 10V$ | - | 0.5 | - | nC |
| Q_{GD} | Gate to Drain (Miller) Charge | $I_D = 0.2A$ | - | 0.4 | - | nC |
| Source-Drain Diode Characteristics | | | | | | |
| V_{SD} | Diode Forward Voltage *2 | $I_S = 0.5A, V_{GS} = 0V$ | - | 0.89 | 1.4 | V |
| t_{rr} | Reverse Recovery Time | $I_F = 1A, V_{GS} = 0V$ | - | 15 | - | ns |
| Q_{rr} | Reverse Recovery Charge | $dI_F/dt = 100A/\mu s$ | - | 8 | - | nC |



Typical Performance Characteristics ($T_A=25^\circ\text{C}$ unless otherwise Specified)

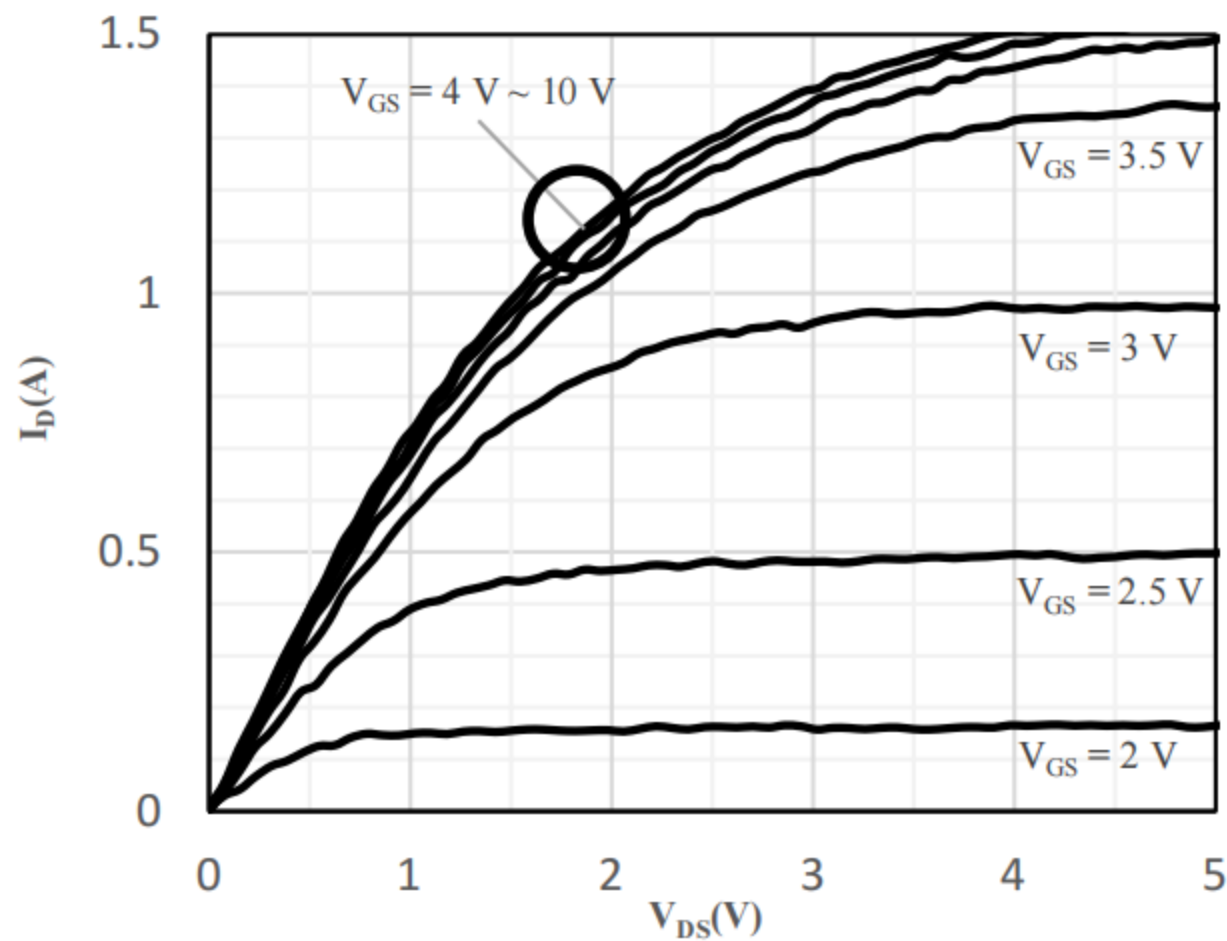

Fig 1 Typical Output Characteristics

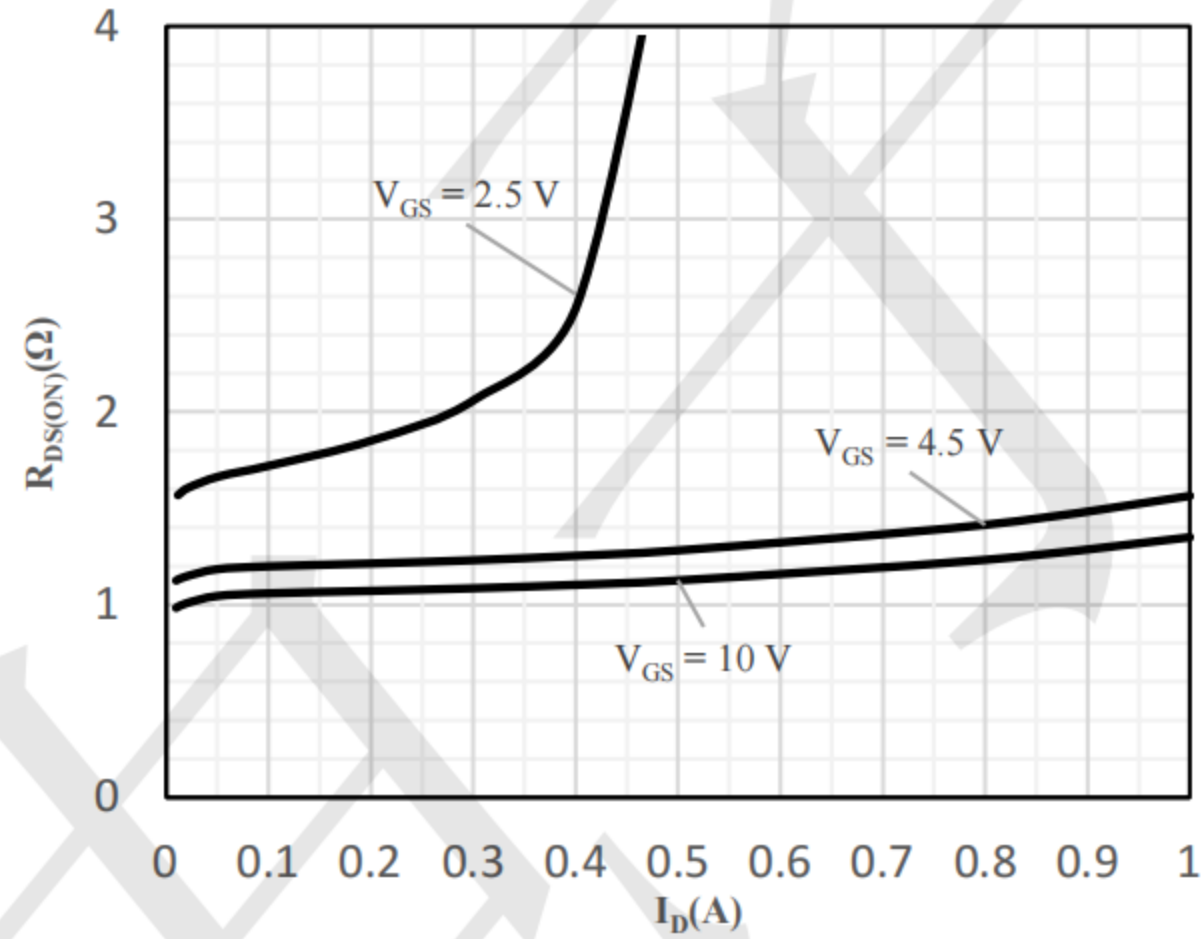

Fig 2 On-Resistance vs. Drain Current and Gate Voltage

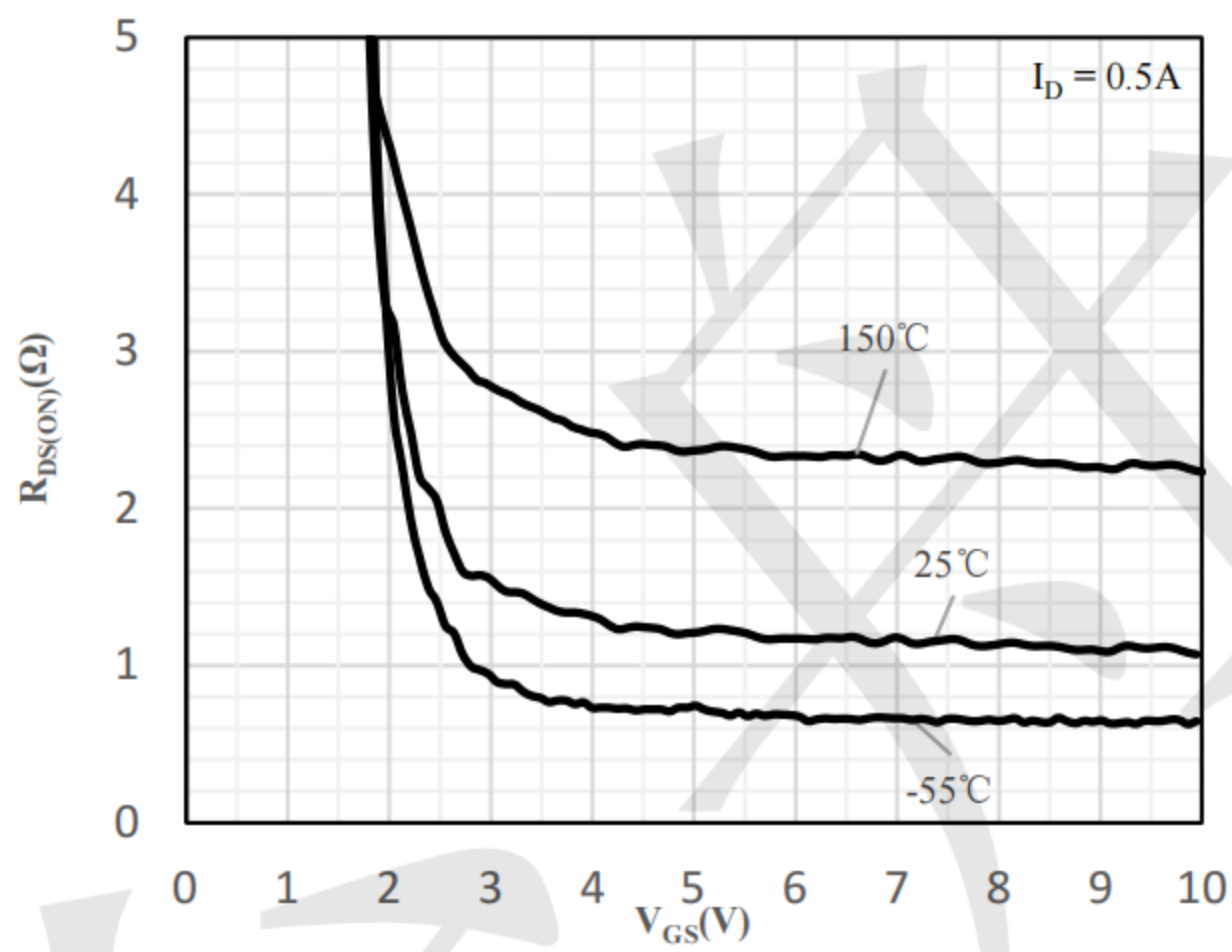

Fig 3 On-Resistance vs. Gate-Source Voltage

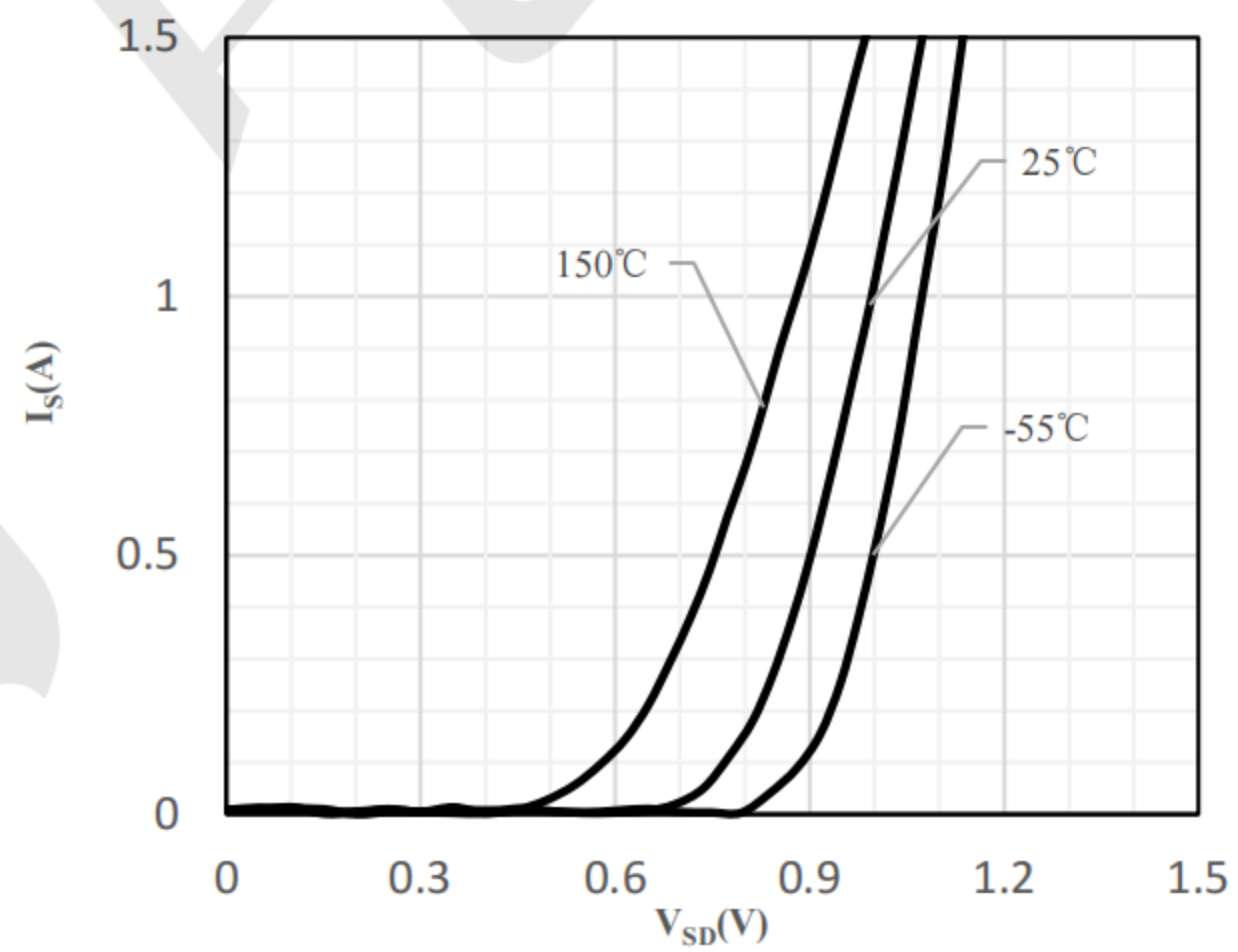

Fig 4 Body-Diode Characteristics

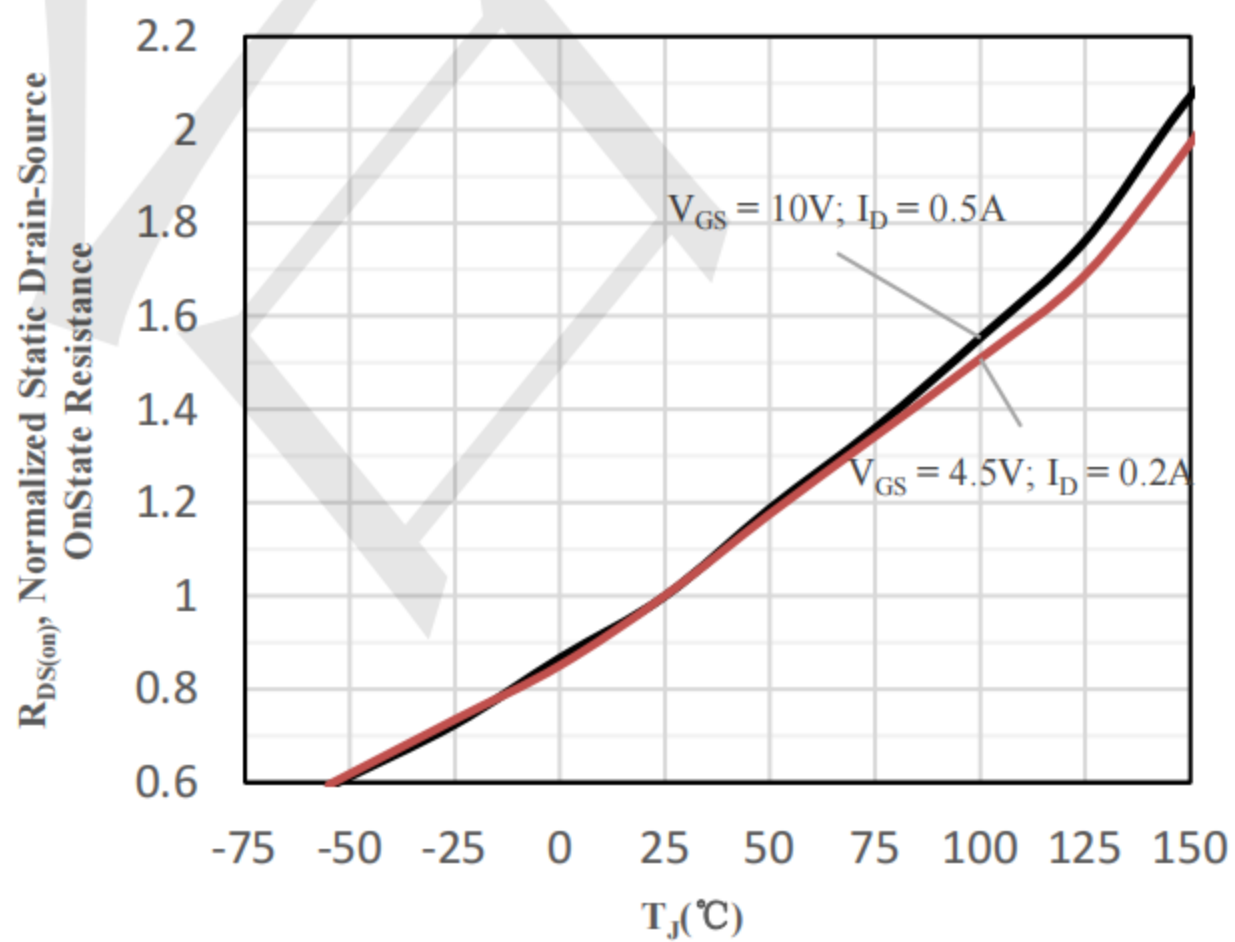

Fig 5 Normalized On-Resistance vs. Junction

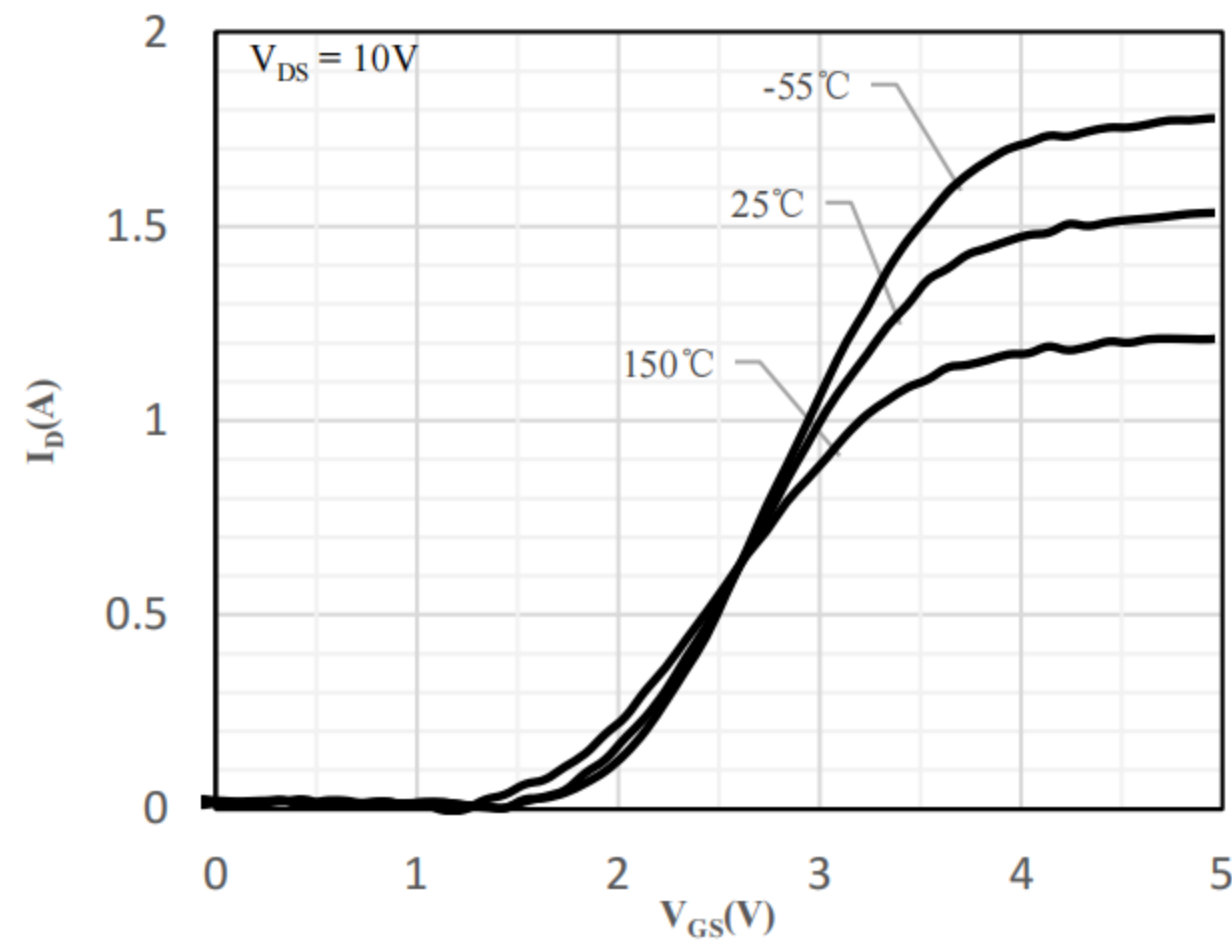

Fig 6 Transfer Characteristics



Typical Performance Characteristics ($T_A=25^\circ\text{C}$ unless otherwise Specified)

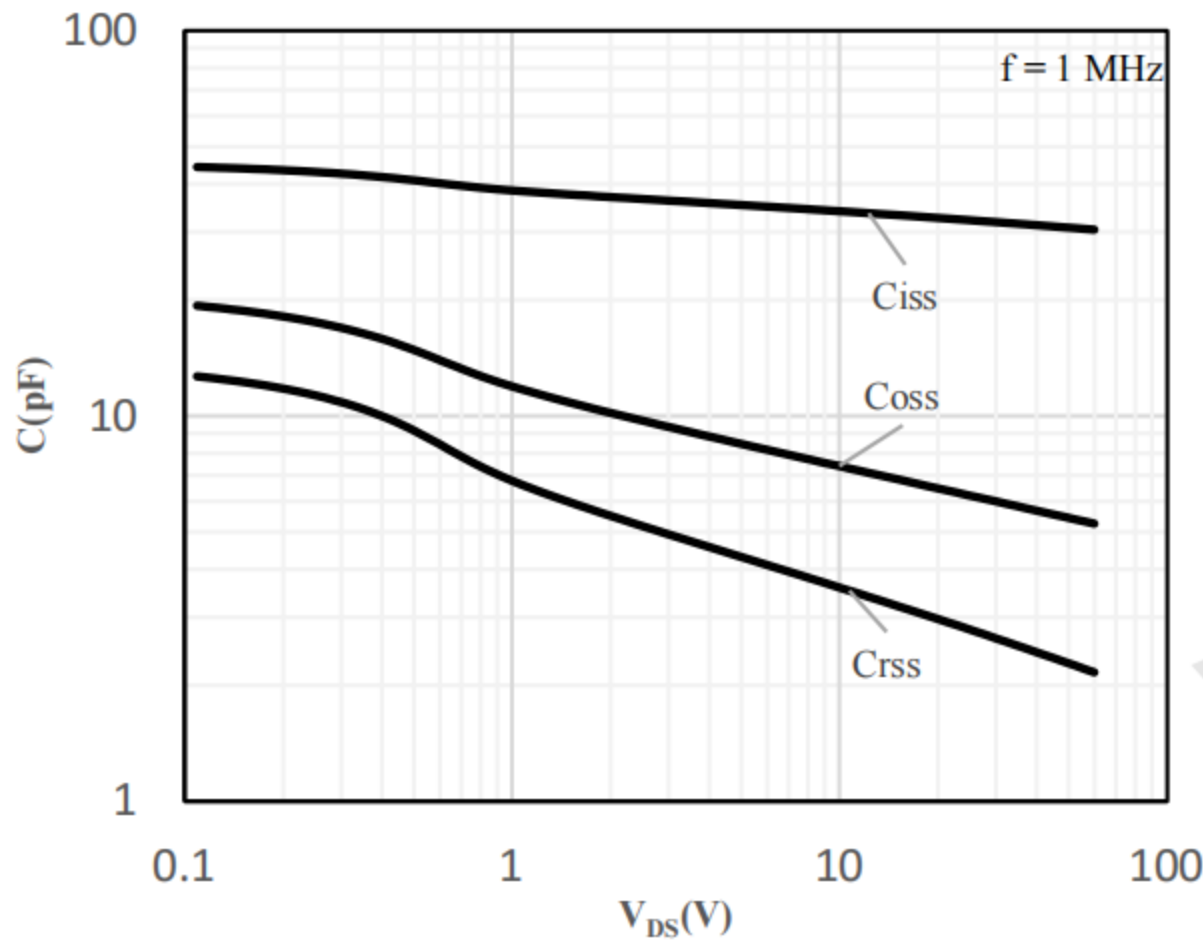

Fig 7 Capacitance Characteristics

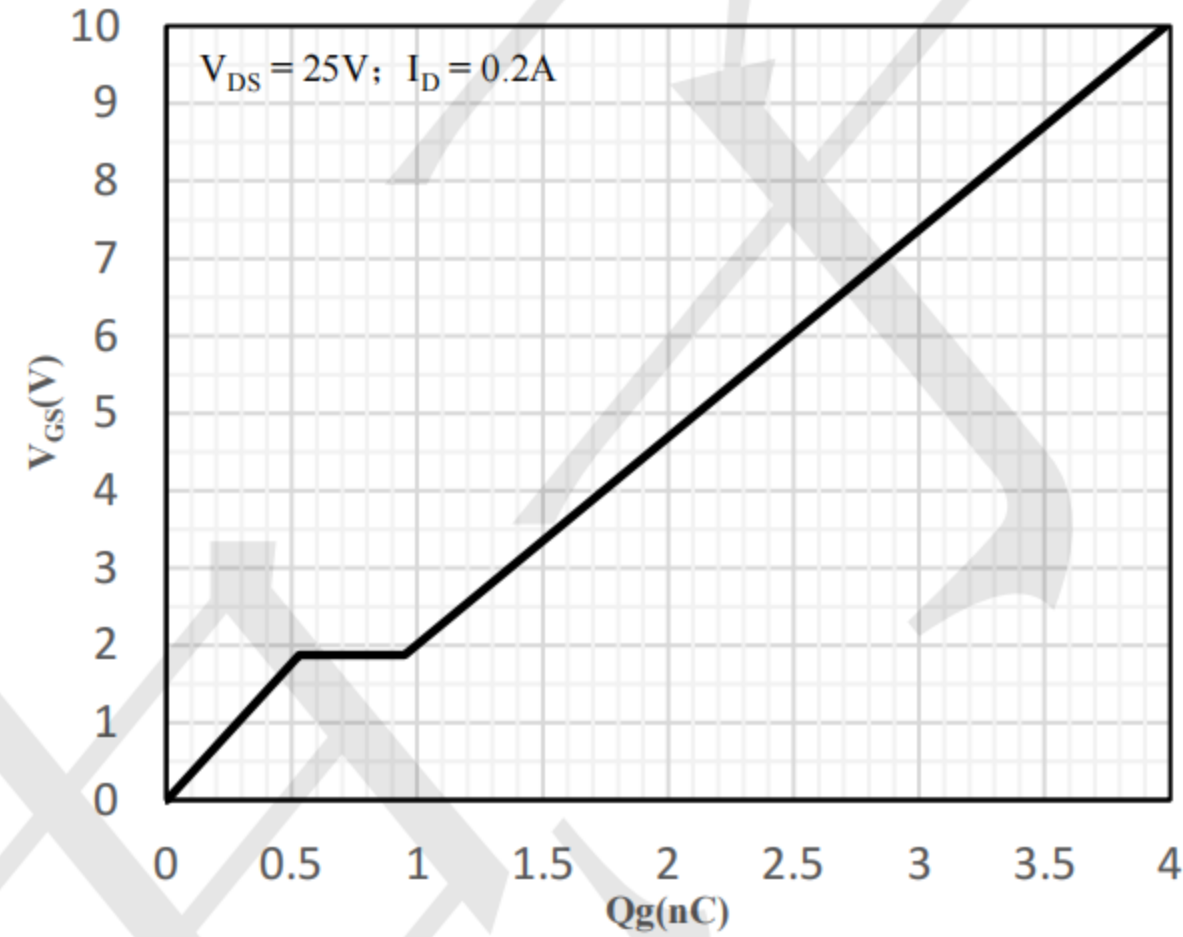

Fig 8 Gate-Charge Characteristics

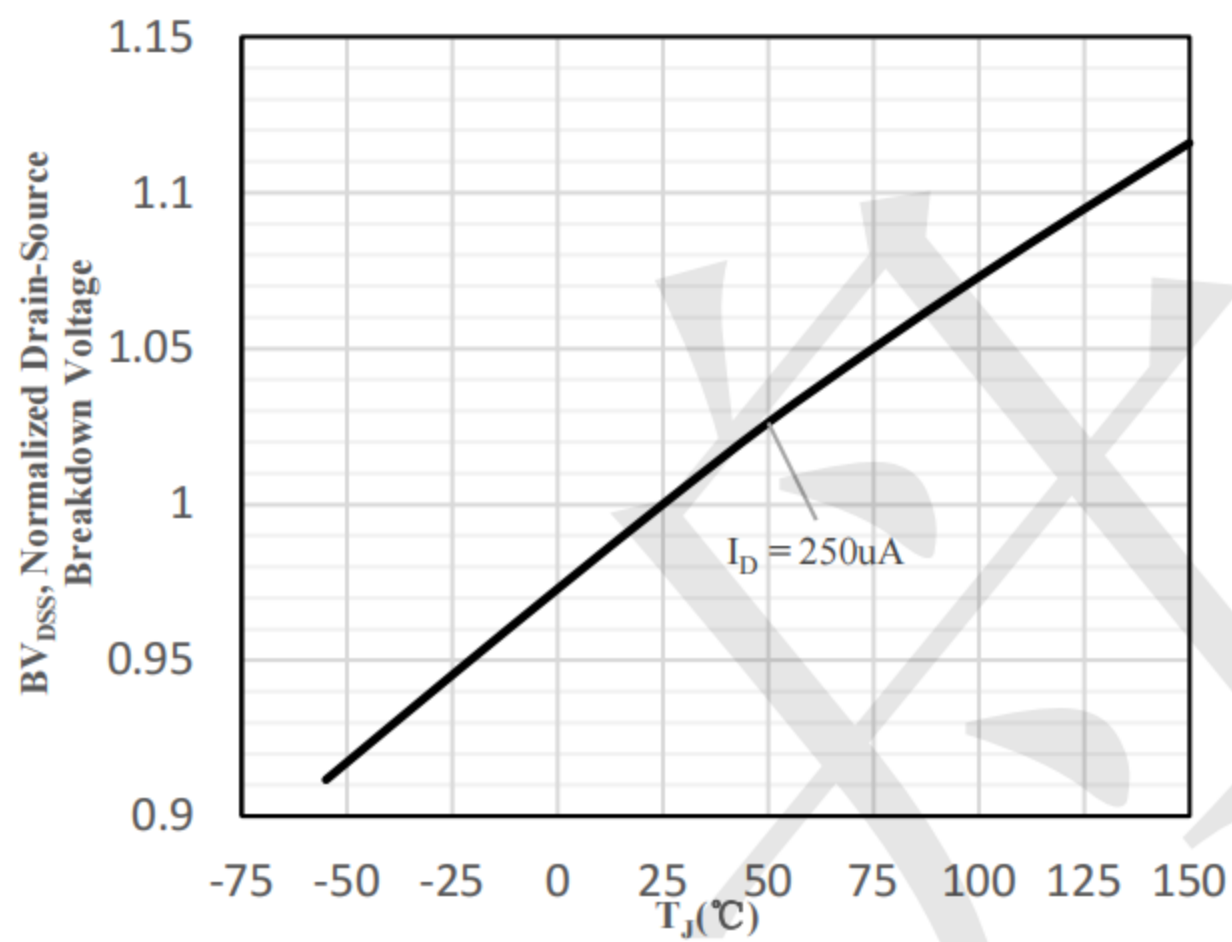

Fig 9 Normalized Breakdown Voltage vs. Junction Temperature

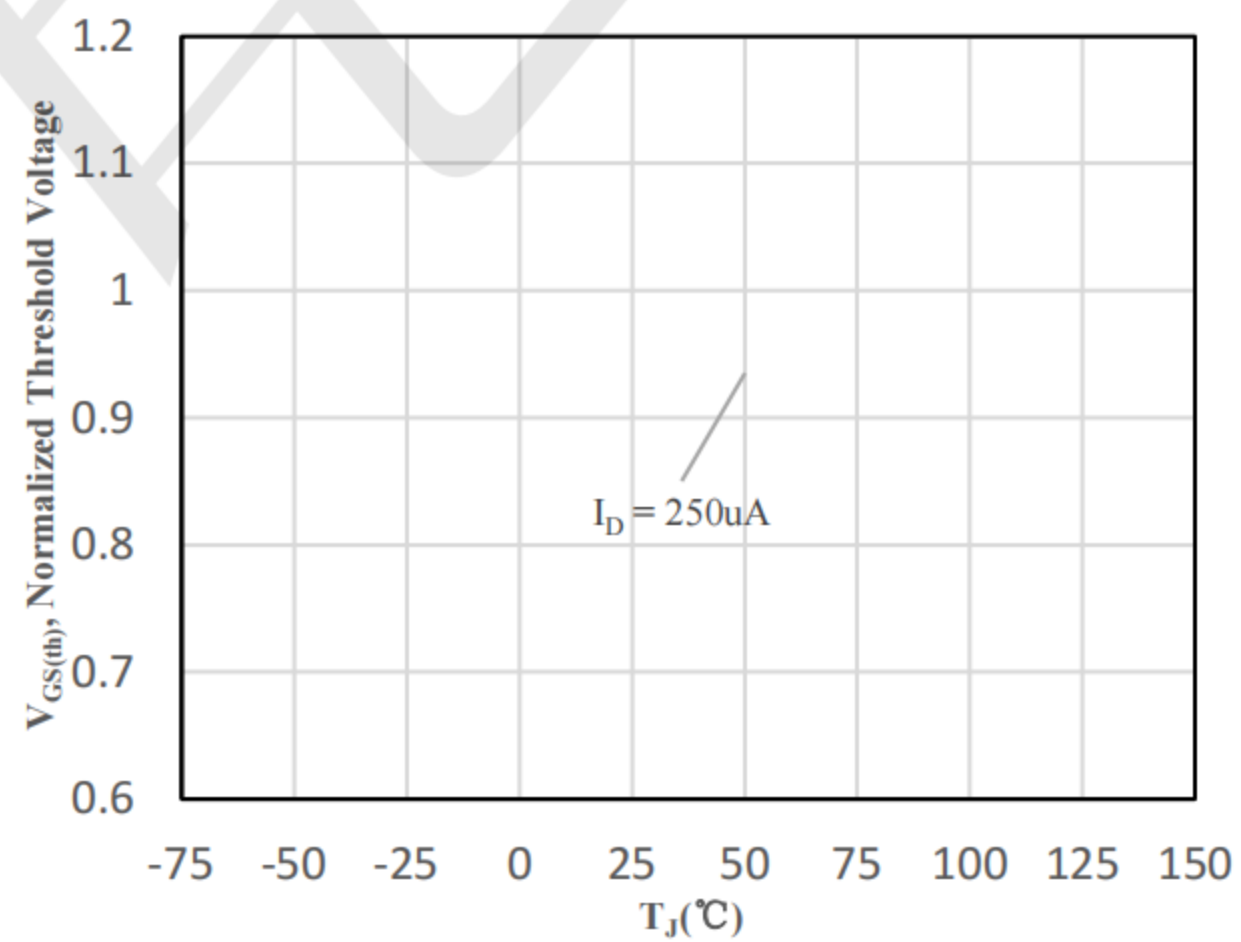

Fig 10 Normalized $V_{GS(th)}$ vs. Junction Temperature

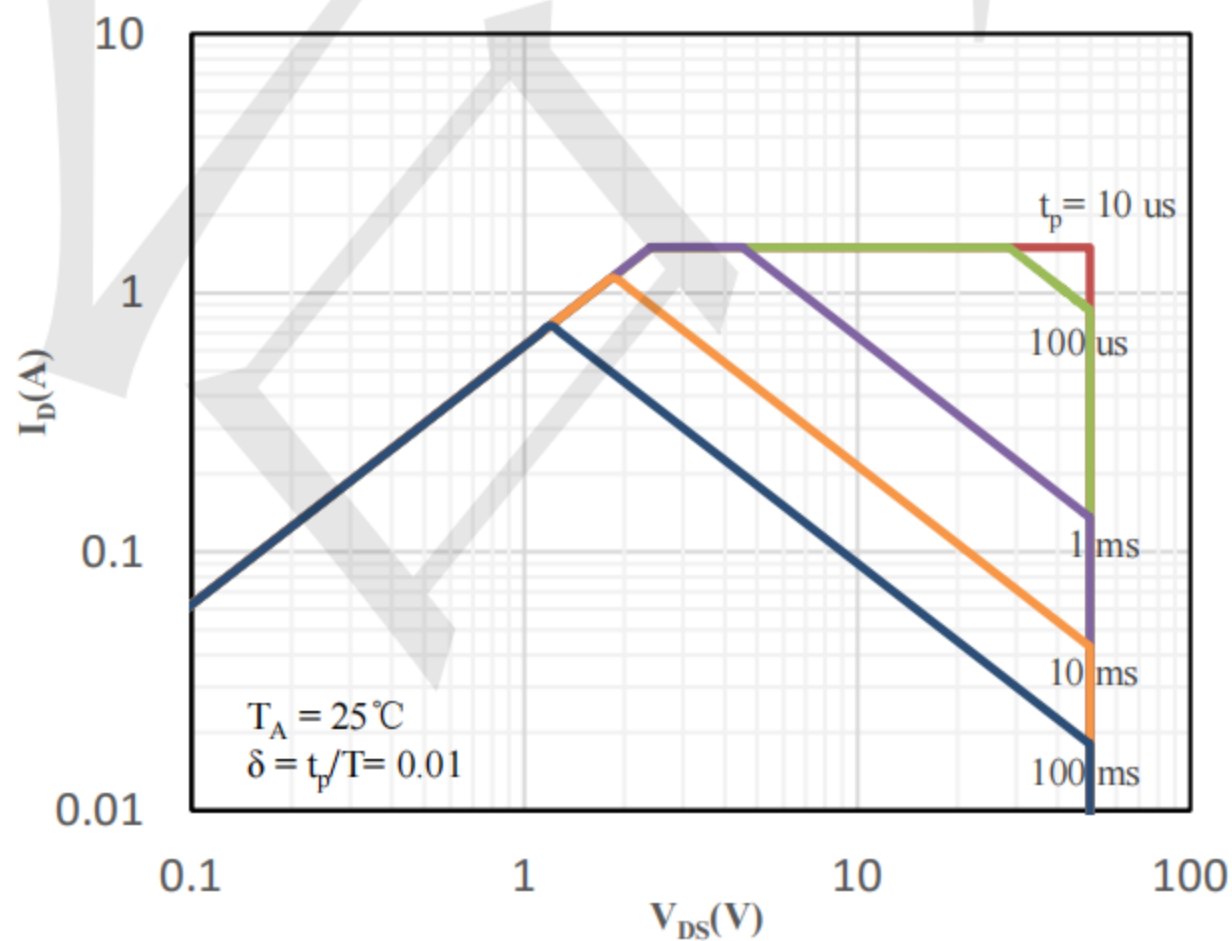

Fig 11 Safe Operation Area

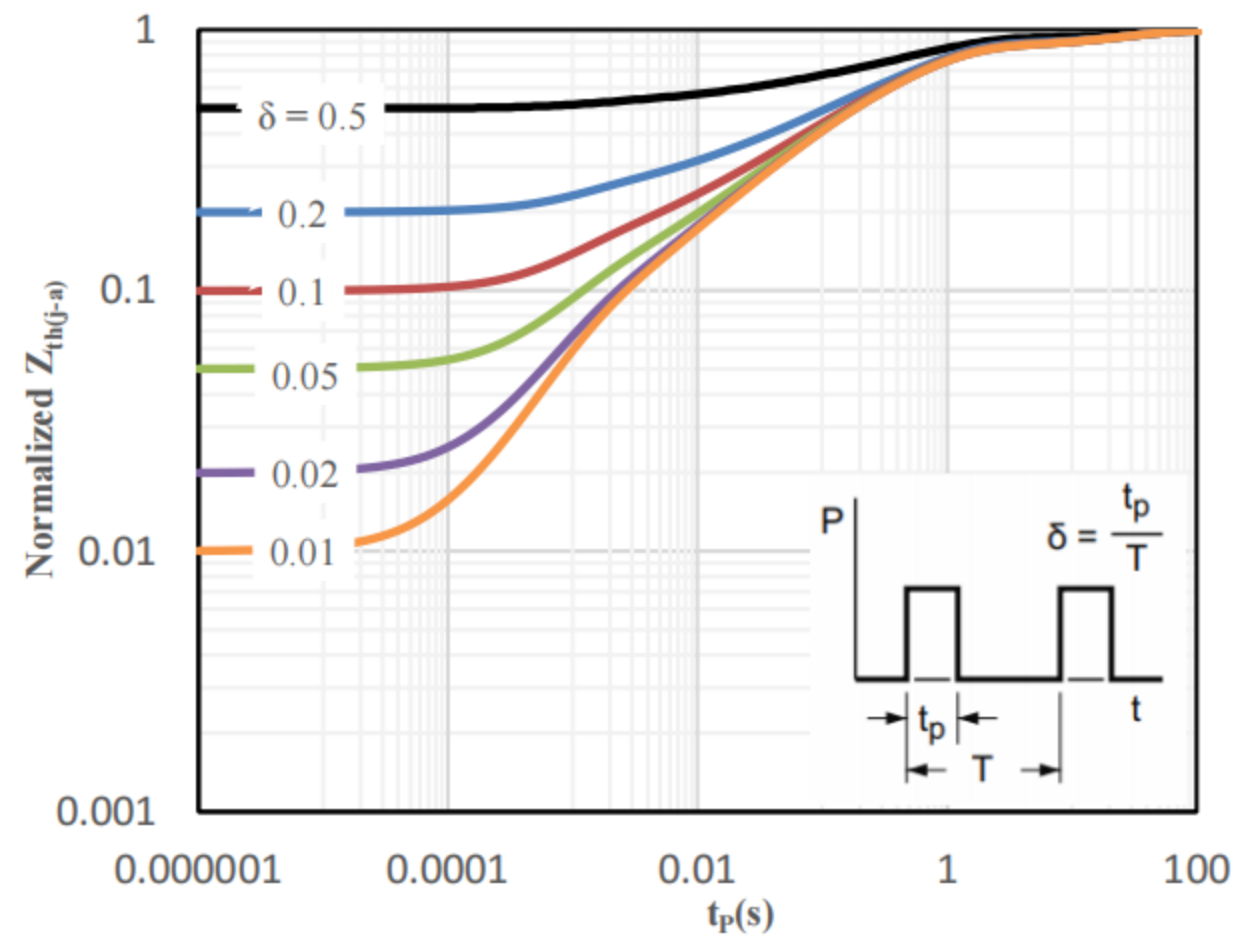
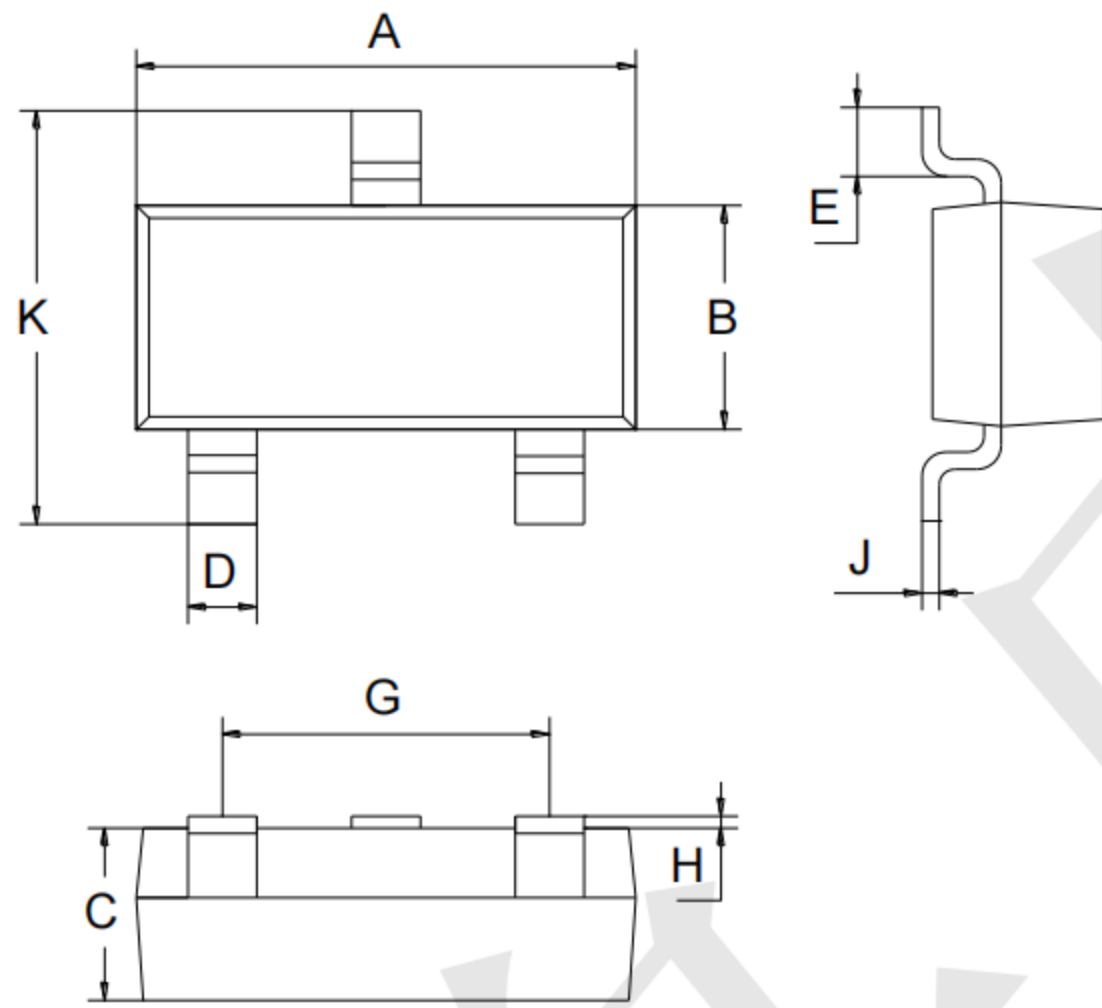

Fig 12 Normalized Maximum transient thermal impedance



Outline Drawing - SOT23



| SOT-23 | | |
|-----------|------|------|
| Dimension | Min. | Max. |
| A | 2.70 | 3.10 |
| B | 1.10 | 1.50 |
| C | 0.90 | 1.10 |
| D | 0.30 | 0.50 |
| E | 0.35 | 0.48 |
| G | 1.80 | 2.00 |
| H | 0.02 | 0.10 |
| J | 0.05 | 0.15 |
| K | 2.20 | 2.60 |

Land Pattern - SOT23

