

# SODHE101-SH thru SODHE108-SH

Surface Mount Glass Passivated High Efficiency Rectifiers

Reverse Voltage 50 to 1000V Forward Current 1.0A

## FEATURES

- \* Plastic package has Underwriters Laboratory Flammability Classification 94V-0
- \* High temperature metallurgically bonded construction
- \* Cavity-free glass passivated junction
- \* Capable of meeting environmental standards of MIL-S-19500
- \* Typical IR less than 1.0 $\mu$ A
- \* High temperature soldering guaranteed: 260°C/10 seconds

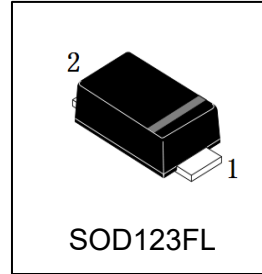

## Mechanical Data

**Case:** JEDEC SOD123-FL/MINI SMA, molded plastic over glass DIE

**Terminals:** Tin Plated, solderable per

MIL-STD-750, Method 2026

**Polarity:** Color band denotes cathode end

**Mounting Position:** Any

**Weight:** 0.0155 g

**Handling precaution:** None

## Electrical Characteristic

### 1. Maximum & Thermal Characteristics Ratings at 25°C ambient temperature unless otherwise specified.

Parameter Symbol	symbol	SODHE 101-SH	SODHE 102-SH	SODHE 103-SH	SODHE 104-SH	SODHE 105-SH	SODHE 106-SH	SODHE 107-SH	SODHE 108-SH	Unit	
Device marking code		HE11	HE12	HE13	HE14	HE15	HE16	HE17	HE18		
Maximum repetitive peak reverse voltage	$V_{RRM}$	50	100	200	300	400	600	800	1000	V	
Maximum RMS voltage	$V_{RMS}$	35	70	140	210	280	420	560	700	V	
Maximum DC blocking voltage	$V_{DC}$	50	100	200	300	400	600	800	1000	V	
Maximum average forward rectified current lead length at $T_C = 75^\circ\text{C}$ (Note 2)	$I_{F(AV)}$	1.0								A	
Peak forward surge current 8.3ms single half sine-wave superimposed on rated load (JEDEC Method)	$I_{FSM}$	30								A	
Typical reverse recovery time (Note 1)	$t_{rr}$	50					75				ns
Typical thermal resistance (Note 2)	$R_{\theta JA}$ $R_{\theta JL}$	170					40				$^\circ\text{C/W}$
Operating junction temperature range	$T_J$	-55 to +150								$^\circ\text{C}$	
storage temperature range	$T_{STG}$	-55 to +150								$^\circ\text{C}$	

### Electrical Characteristics Ratings at 25°C ambient temperature unless otherwise specified.

Parameter Symbol	symbol	SODHE 101-SH	SODHE 102-SH	SODHE 103-SH	SODHE 104-SH	SODHE 105-SH	SODHE 106-SH	SODHE 107-SH	SODHE 108-SH	Unit	
Maximum instantaneous forward voltage at 1.0A	$V_F$	1.0			1.25		1.7			V	
Maximum DC reverse current at rated DC blocking voltage $T_A = 25^\circ\text{C}$ $T_J = 100^\circ\text{C}$	$I_R$	5.0					100				$\mu\text{A}$
Typical junction capacitance at 4.0V, 1MHz (Note 2)	$C_J$	15.0								PF	

NOTES:

1.  $I_F = 0.5\text{A}$ ,  $I_R = 1.0\text{A}$ ,  $IRR = 0.25\text{A}$
2.  $8.0\text{mm}^2$  (.013mm thick) land areas

# SODHE101-SH thru SODHE108-SH

## 2. Characteristic Curves (TA = 25°C unless otherwise noted)

Fig. 1 – Forward Current Derating Curve

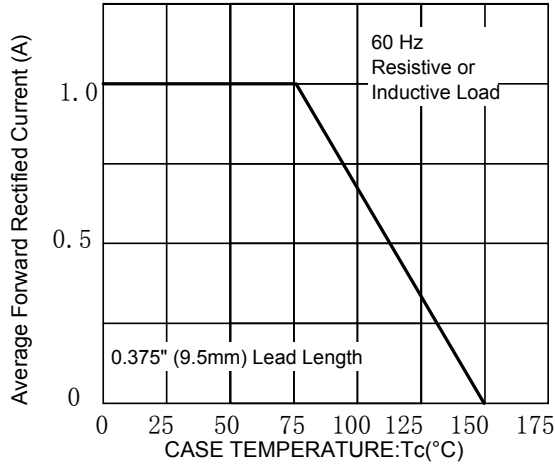

Fig. 2 – Maximum Non-repetitive Peak Forward Surge Current

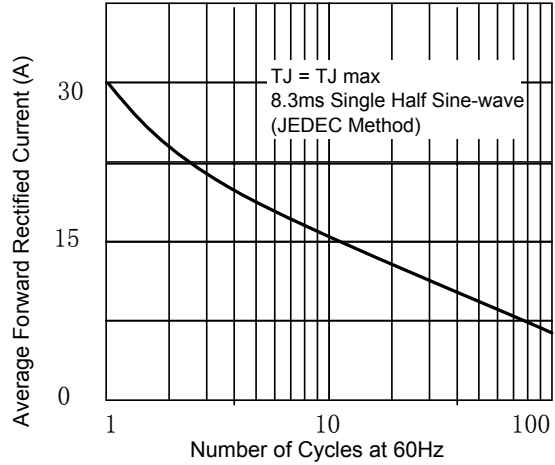

Fig 3. – Typical Instantaneous Forward Characteristics

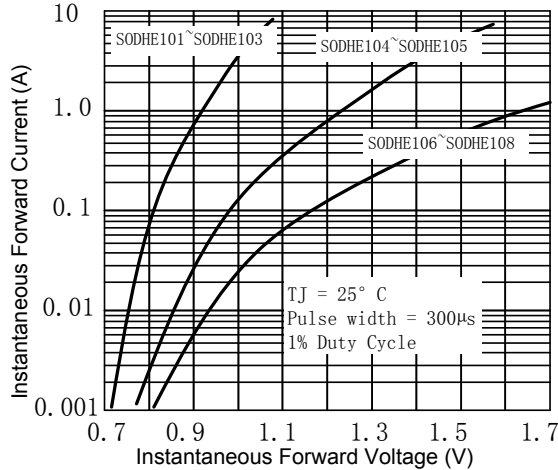

Fig 4. – Typical Reverse Characteristics

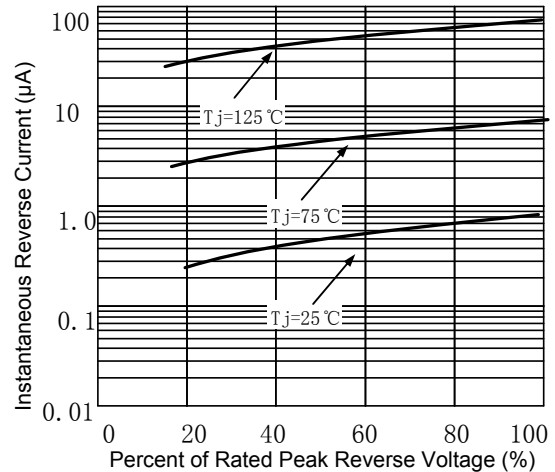

Fig 5. – typical transient thermal impedance

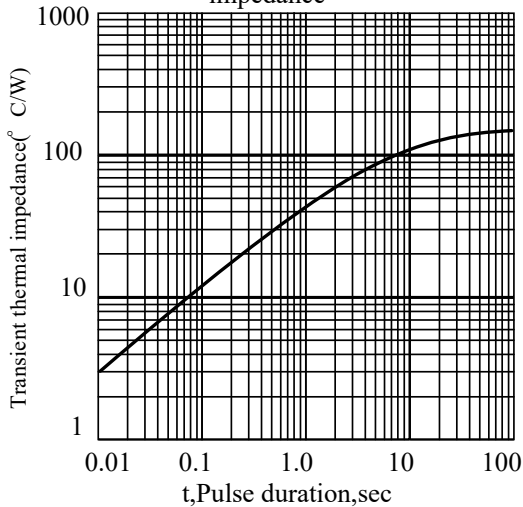
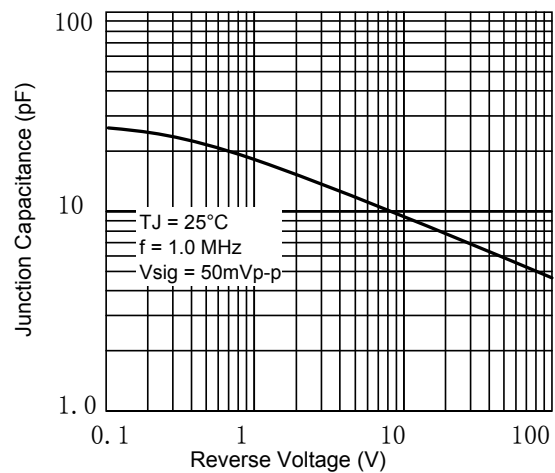
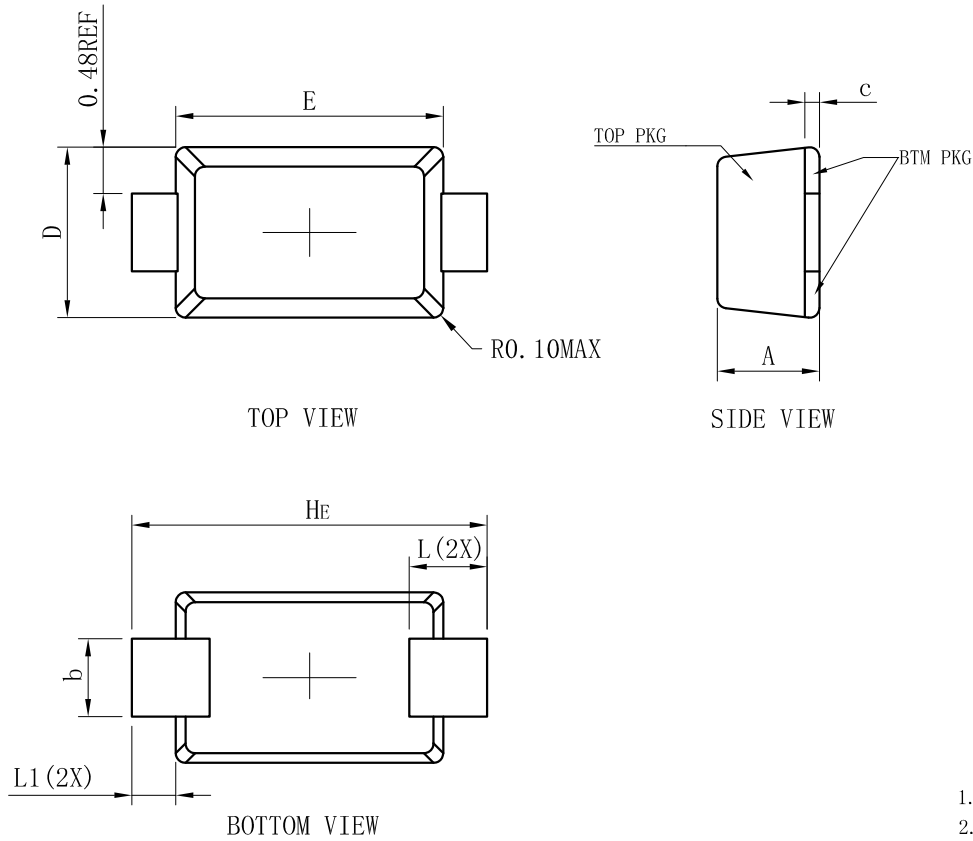

Fig 6. – Typical Junction Capacitance



### 3.OUTLINE AND DIMENSIONS



SOD123FL			
DIM	MIN	NOR	MAX
A	0.90	1.05	1.15
b	0.75	0.80	0.95
L	0.50	0.80	1.10
E	2.60	2.75	2.90
D	1.60	1.75	1.90
HE	3.50	3.65	3.80
c	0.12	0.17	0.22
L1	0.25	0.45	0.65
All Dimensions in mm			

#### GENERAL NOTES

1. Top package surface finish  $Ra0.4\pm0.2\mu m$
2. Bottom package surface finish  $Ra0.7\pm0.2\mu m$
3. Side package surface finish  $Ra0.4\pm0.2\mu m$

### 4.SOLDERING FOOTPRINT

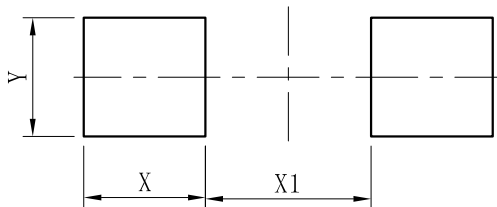

DIM	(mm)
X	1.20
Y	1.10
X1	2.00

# SODHE101-SH thru SODHE108-SH

## 5.Suggested thermal profile for soldering process

1. Storage environment : Temperature=5~40°C Humidity=55±25%
2. Reflow soldering of surface-mount device

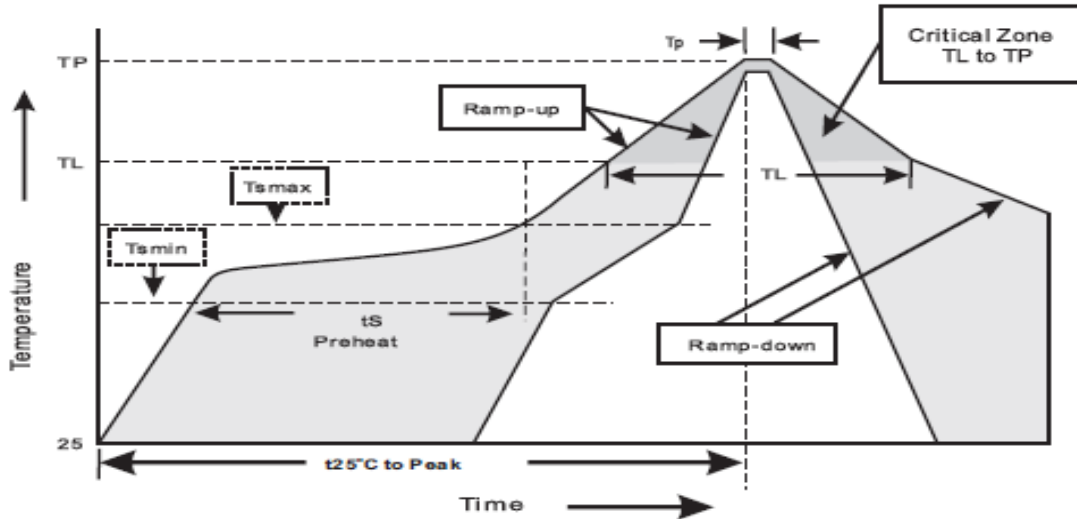

3. Reflow soldering

Profile Feature	Soldering Condition
Average ramp-up rate(T <sub>L</sub> to T <sub>P</sub> )	<3°C/sec
Preheat - Temperature Min(T <sub>smin</sub> ) - Temperature Max(T <sub>smax</sub> ) - Time(min to max)(t <sub>s</sub> )	150°C 200°C 60~120sec
T <sub>smax</sub> to T <sub>L</sub> - Ramp-up Rate	<3sec
Time maintained above: - Temperature (T <sub>L</sub> ) - Time(t <sub>L</sub> )	217°C 60-260sec
Peak Temperature(T <sub>P</sub> )	255 -0/+5°C
Time within 5°C of actual Peak Temperature(T <sub>P</sub> )	10~30sec
Ramp-down Rate	<6°C/sec
Time 25°C to Peak Temperature	<6minutes

## **DISCLAIMER**

- Curve guarantee in the specification. The curve of test items with electric parameter is used as quality guarantee. The curve of test items without electric parameter is used as reference only.
- Before you use our Products for new Project, you are requested to carefully read this document and fully understand its contents. LRC shall not be in any way responsible or liable for failure, malfunction or accident arising from the use of any LRC's Products against warning, caution or note contained in this document.
- All information contained in this document is current as of the issuing date and subject to change without any prior notice. Before purchasing or using LRC's Products, please confirm the latest information with a LRC sales representative.



Proprietary Information

# Title: Power Packages Product Packing Specification 功率产品包装规范

Document Number: APS-QA-QS-009

Revision C

Page 3 of 6



### 8.1.2 Label position and QA stamp position.(Empty area) 标签张贴位置及QA印章位置。(印章盖 标签空白区)

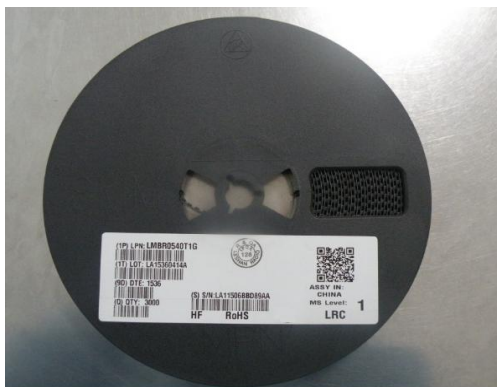

7英寸卷盘标签张贴及QA印章位置



13英寸卷盘标签张贴及QA印章位置

### 8.1.3 Ensure direction In the same reel. The same steel coil plate direction, With antistatic bubble to package reel. Refer to the below picture.

同一箱内的卷盘方向一致,用防静电泡沫对卷盘进行包裹。

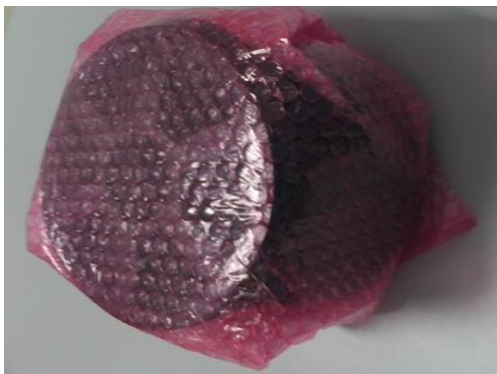

7英寸卷盘防静电泡沫包裹



13英寸卷盘防静电泡沫包裹



Proprietary Information

# Title: Power Packages Product Packing Specification

## 功率产品包装规范

Document Number: APS-QA-QS-009

Revision C

Page 4 of 6

8.1.4 Put in the antistatic packing box after packaged reels. And QA stamp on the box label .

将包装好的卷盘放入防静电纸箱中，并 盒标签上盖章。



7 英寸卷盘内盒及标签



13 英寸卷盘内盒及标签

8.1.5 Product use printing inner box. 产品使用LRC印字内箱。



7英寸卷盘内箱印字（侧面）



13英寸卷盘内箱印字（正面）

8.1.6 Inner box packing quantity requirement. 内盒包装数量要求。

Product Description	QTY
SOD123-FL	1-10Reels
SOD323-HE	1-10Reels
SMA-FL	1-7Reels
SMB-FL	1-4Reels

8.1.7 With transparent tape sealing. 透明胶带封箱。





Proprietary Information

# Title: Power Packages Product Packing Specification 功率产品包装规范

Document Number: APS-QA-QS-009

Revision C

Page 5 of 6



7英寸内箱封盒



13英寸内箱封盒

### 8.1.8 Outer box size and packing quantity requirement, 外箱尺寸及包装数量要求。

Product Description	卷盘尺寸	Height (H)	Width (W)	Length (L)	Max. Qty
Power Device	7 英寸	410mm	400mm	445mm	12
Power Device	13 英寸	410mm	400mm	445mm	5



7 英寸卷盘产品装箱



13 英寸卷盘产品装箱

统一方向





Proprietary Information

# Title: Power Packages Marking & Taping Specification

## 功率封装字模和编带规范

Document Number: APS-QA-QS-010

Revision C

Page 6 of 9

### 8.2 Standard Products Taping Specification

标准产品编带规范

#### 8.2.1 Tape length of no component

空带长度说明

Taping leader length 引导部分:  $440\text{mm} \pm 40\text{mm}$  , Tape trailer 尾部:  $200\text{mm} \pm 40\text{mm}$

Figure 4

Tape Ends For Finished Goods Reel

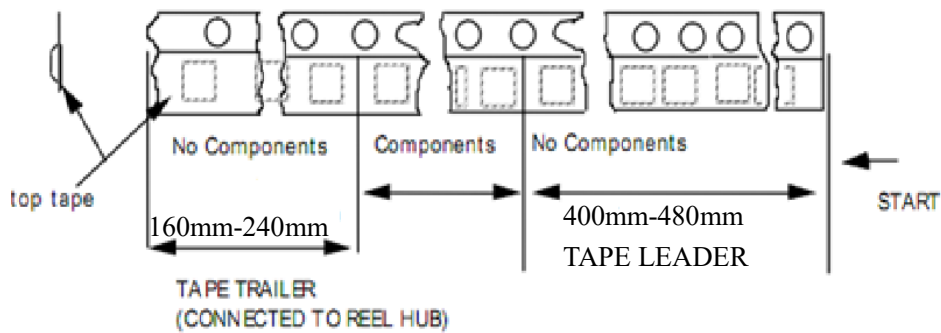

#### 8.2.2 Component packaging orientation: The cathode lead is close to the carrier tape's index hole.

产品放置方向: 印阴极带引脚邻近载带索引孔





Proprietary Information

# Title: Power Packages Marking & Taping Specification

功率封装字模和编带规范

Document Number: APS-QA-QS-010

Revision C

Page 7 of 9

## 8.2.3 Tape enwind orientation

编带缠绕方向要求

