

SOD-323 Plastic-Encapsulate Diodes

1SS357 Schottky Barrier Diode

FEATURES

- Low current rectifier schottky diode
- Low voltage, low inductance
- For power supply

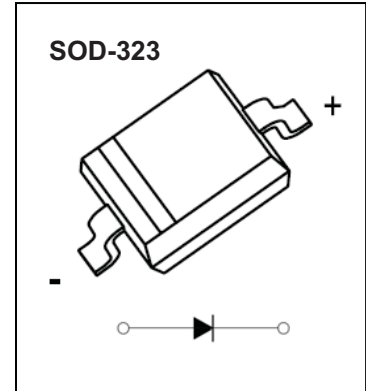

MARKING

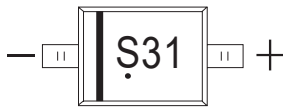

The marking bar indicates the cathode
Solid dot = Green molding compound device.

Maximum Ratings and Electrical Characteristics, Single Diode @Ta=25°C

Parameter	Symbol	Limit	Unit
Peak reverse voltage	V_{RM}	45	V
DC reverse voltage	V_R	40	V
Mean rectifying current	I_O	0.1	A
Non-repetitive Peak Forward Surge Current@t=8.3ms	I_{FSM}	1	A
Power dissipation	P_D	200	mW
Thermal Resistance Junction to Ambient	$R_{\theta JA}$	500	°C/W
Operating Junction Temperature Range	T_j	-40 ~ +125	°C
Storage Temperature Range	T_{stg}	-55 ~ +150	°C

Electrical Ratings @Ta=25°C

Parameter	Symbol	Min	Typ	Max	Unit	Conditions
Forward voltage	V_F			0.35	V	$I_F=1mA$
Forward voltage	V_F			0.45	V	$I_F=10mA$
Forward voltage	V_F			0.60	V	$I_F=100mA$
Reverse current	I_R			5	μA	$V_R=40V$
Capacitance between terminals	C_T			25	pF	$V_R=0V, f=1MHz$

Typical Characteristics

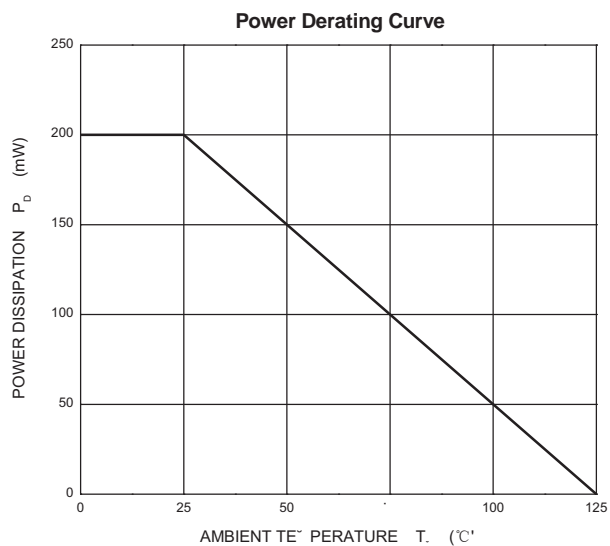
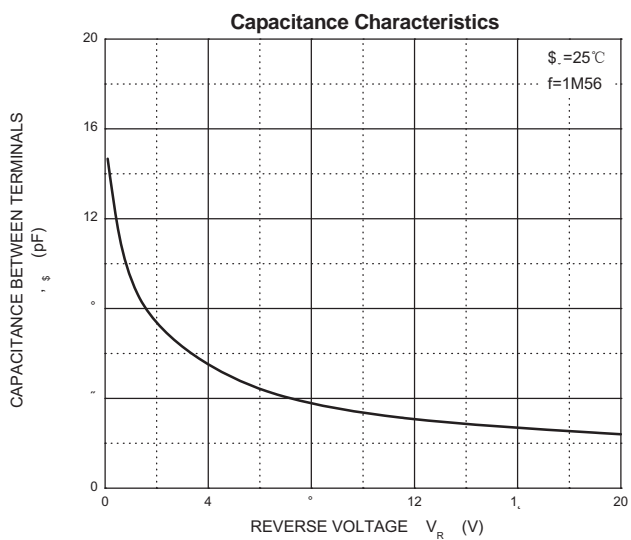
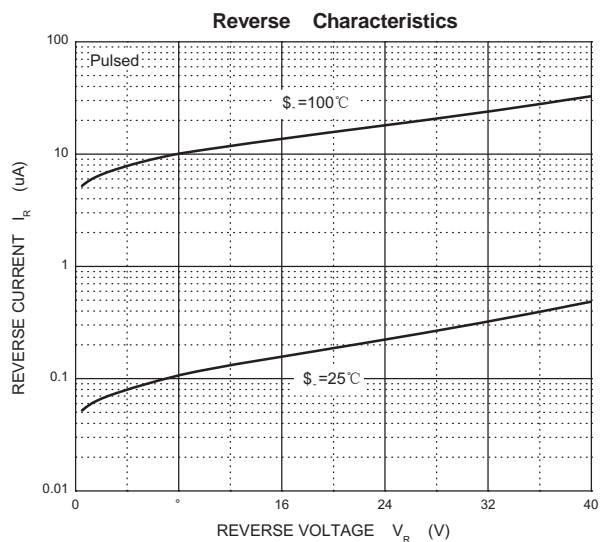
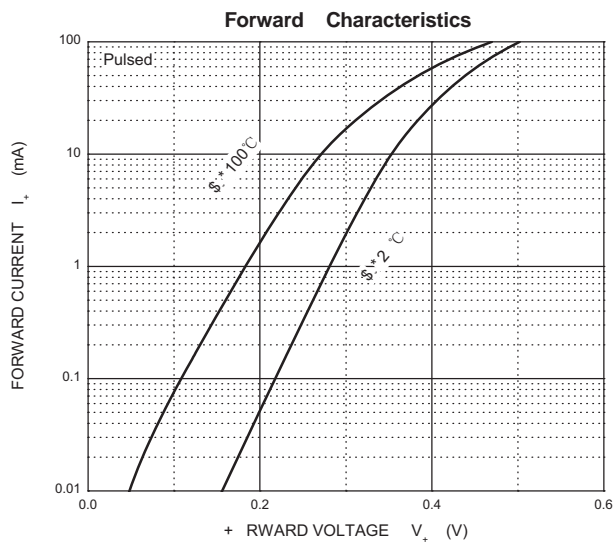

SOD-323 Package Outline Dimensions

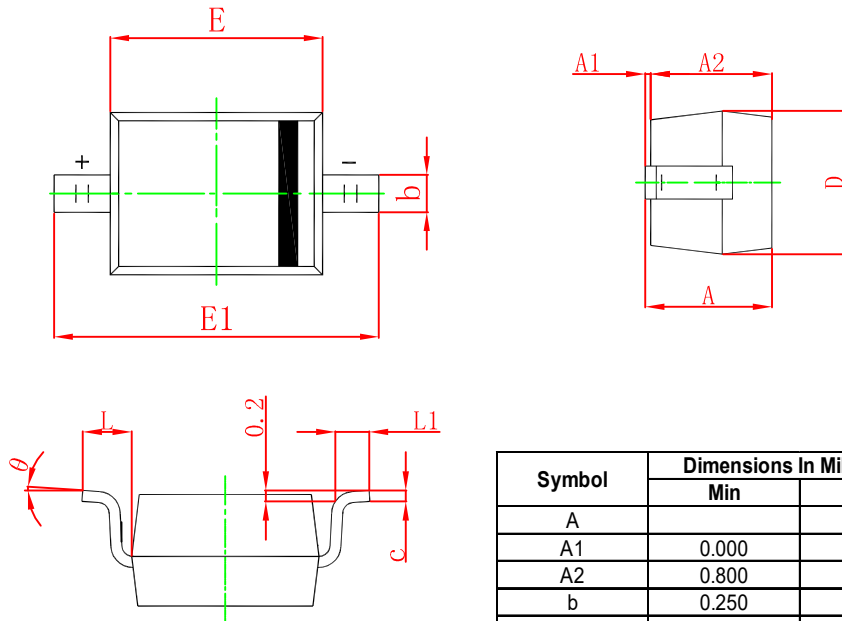

Symbol	Dimensions In Millimeters		Dimensions In Inches	
	Min	Max	Min	Max
A		1.100		0.043
A1	0.000	0.100	0.000	0.004
A2	0.800	1.000	0.031	0.039
b	0.250	0.350	0.010	0.014
c	0.080	0.150	0.003	0.006
D	1.200	1.400	0.047	0.055
E	1.600	1.800	0.063	0.071
E1	2.500	2.750	0.098	0.108
L	0.475 REF		0.019 REF	
L1	0.250	0.400	0.010	0.016
θ	0°		8°	

SOD-323 Suggested Pad Layout

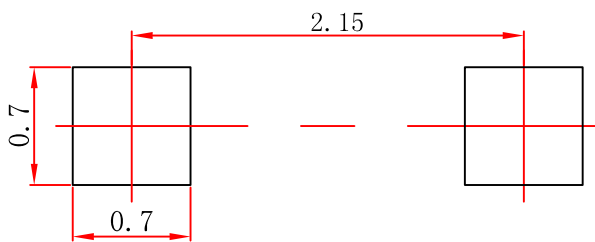

Note:

1. Controlling dimension: in millimeters.
2. General tolerance: ± 0.05mm.
3. The pad layout is for reference purposes only.

NOTICE

JSCJ reserves the right to make modifications, enhancements, improvements, corrections or other changes without further notice to any product herein. JSCJ does not assume any liability arising out of the application or use of any product described herein.

SOD-323 Tape and Reel

SOD-323 Embossed Carrier Tape

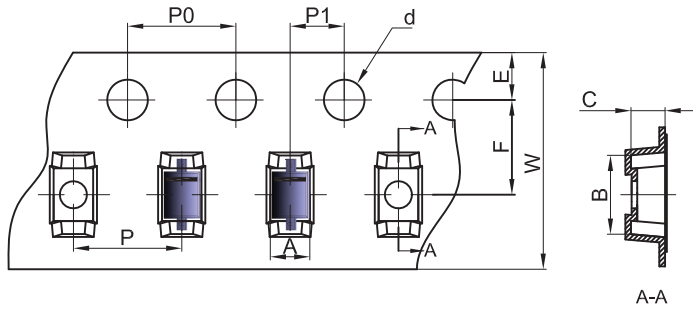

Packaging Description:

SOD-323 parts are shipped in tape. The carrier tape is made from a dissipative (carbon filled) polycarbonate resin. The cover tape is a multilayer film (Heat Activated Adhesive in nature) primarily composed of polyester film, adhesive layer, sealant, and anti-static sprayed agent. These reeled parts in standard option are shipped with 3,000 units per 7" or 17.8cm diameter reel. The reels are clear in color and is made of polystyrene plastic (anti-static coated).

Dimensions are in millimeter										
Pkg type	A	B	C	d	E	F	P0	P	P1	W
SOD-323	1.48	3.3	1.25	Ø1.50	1.75	3.50	4.00	4.00	2.00	8.00

SOD-323 Tape Leader and Trailer

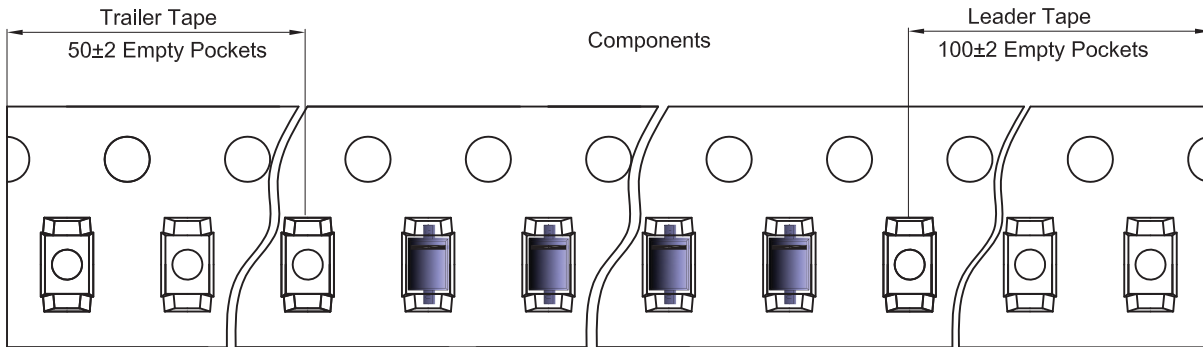

SOD-323 Reel

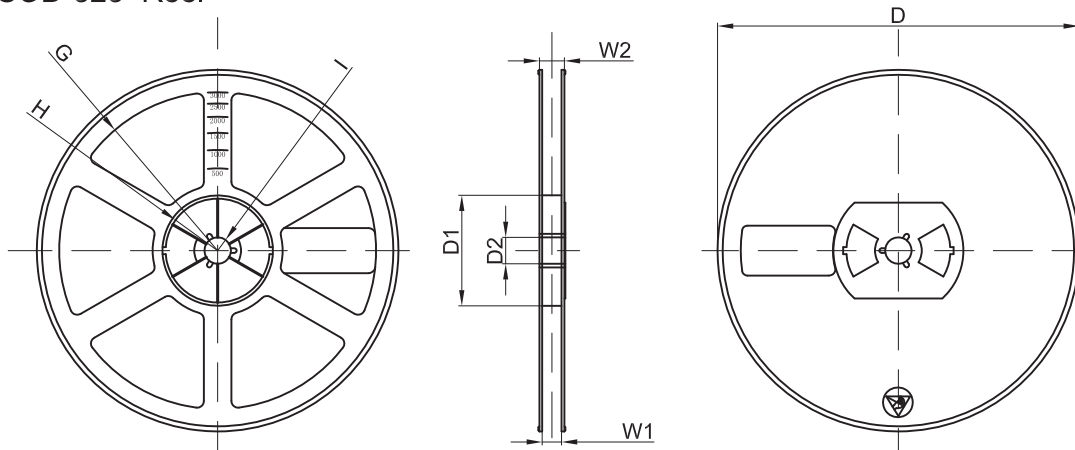

Dimensions are in millimeter								
Reel Option	D	D1	D2	G	H	I	W1	W2
7"Dia	Ø178.00	54.40	13.00	R78.00	R25.60	R6.50	9.50	12.30

REEL	Reel Size	Box	Box Size(mm)	Carton	Carton Size(mm)	G.W.(kg)
3000 pcs	7 inch	45,000 pcs	203×203×195	180,000 pcs	438×438×220	